



Mag Connection Team is proud to deliver all the parts you need for your builds every week! In this catalog, you'll find a comprehensive list of brands from which you can place orders and access all the product lines they offer in their catalogs.

**Mag Connection is the best way to get your favorite parts !**

- |   |  |
|---|--|
| American<br>Suspensions Arlen<br>Ness<br>Arnott Suspension<br>Bad Dad<br>Baker<br>Beringer Brakes<br>Big Bike Parts<br>Biker Choice<br>Champion<br>Corbin<br>D&D Exhausts<br>Daytona twin Tec<br>Dead Center Cycles<br>Dirty Bird Concept<br>DNA Specialties<br>Dynojet<br>Easy Rider Japan<br>EMD<br>Evolution Industrie<br>Hard Drive<br>Headwinds<br>Heartland<br>Image Motorcycles<br>Kraftech<br>Kuryakyn<br>Kustom Tech<br>La Rosa Design<br>Ledsled Custom<br>MCJ Exhausts<br>Mid USA<br>Midwest<br>Mooneyes | National Cycle<br>No Line<br>No Limit Custom<br>O.D.C.<br>Paughco<br>Paul Yaffe<br>Performance<br>Machine Pingel<br>Platinum<br>Suspensions Pro One<br>RC Components<br>Rebufinni<br>Red Line Oil<br>Red Thunder<br>Ricks<br>Ride Wright Wheels<br>S&S Cycles<br>Samson<br>Sebring Exhausts<br>Storz Performance<br>Supertrapp<br>Spitfire Motorcycles<br>TC Bros<br>Tech Cycles<br>Thunderbike<br>Thunderheader<br>Thundermax<br>Trask Performance<br>Two Brothers Racing<br>V-Twin Mfg<br>VG Frame<br>Vity's Design<br>Zippers |
|---|--|

And if you have some special ask regarding some other brands that you need. Just ask!



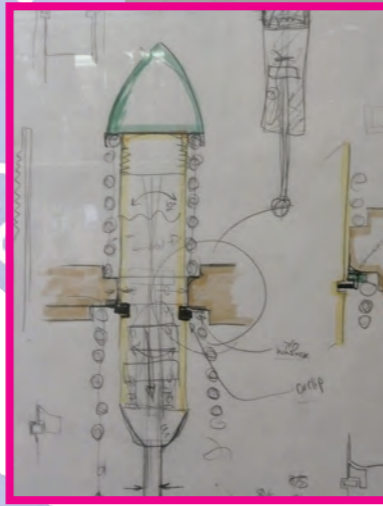
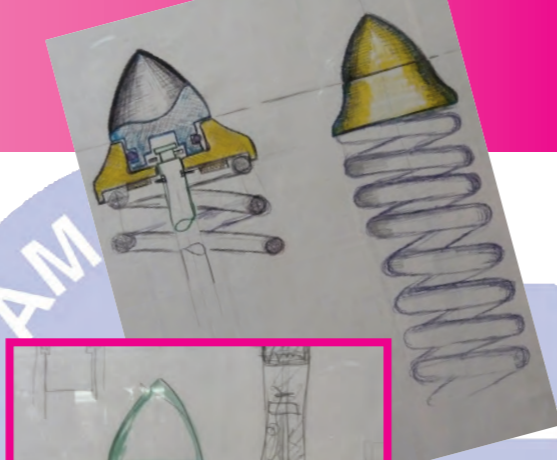

*American Suspension was founded in 1997 by Vince Costa, a former Formula 1 750 champion with a masters in mechanical engineering heritage, the company is at the forefront of innovation.*

*Our technology is proven by millions of miles on thousands of bikes. All parts sold are 100% researched, manufactured, and shipped from our usa facility here at beautiful Anaheim, California. We are so confident in our offerings, that we provide a limited lifetime warranty for each product sold. Rest assured that when you purchase an American Suspension brand product, you are making an investment in not just your ride but yourself.*

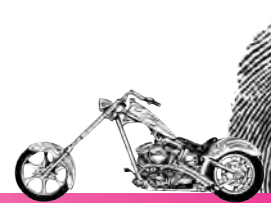



## The Ease of a bolt on with reliability of a weld on ! Perfect trail for any 23", 26", 30" or 32" conversions

Race Track Inspired Bearing Adjustment System. Set and Forget.

Fork Extensions completely fill the top tree to protect from high speed wobble.

Convert any bike to a Road Glide with a Bolt On Fairing Mount.

Multiple Redundant Fail Safe Systems provide the SAFEST Bolt On Neck.

Pressed in Stem gives absolute best handling of any available Bolt on Neck.

The ONLY ONE-PIECE Bolt On available in the market.

- BB/B-26-14 ... 23" & 26" Bolt Neck Kit 2014 Up
- BB/B-26-08 ... 23" & 26" Bolt Neck Kit 2001-2008
- BB/B-26-09 ... 23" & 26" Bolt Neck Kit 2009-2013

- BB/B-30-14 ... 30" & 32" Bolt Neck Kit 2014 Up
- BB/B-30-08 ... 30" & 32" Bolt Neck Kit 2001-2008
- BB/B-30-09 ... 30" & 32" Bolt Neck Kit 2009-2013

For 23" & 26"

For 30" & 32"



## AR-70 Drop in Air Piston Kit

Easy Drop In upgrade for your stock fork legs with Air Ride and Perimeter Valve fork kit

Works for any 41mm or 49mm fork legs

AR-70 drop in air piston kit converts any stock fork to air ride quickly.

Fork 45 Performance Spring

RPA - Remote Preload Adjuster

Air Cap

Fork 45 Perimeter Valve Cartridge system. No need to modify stock inner tube. True "Bolt on modification."

- BB/AR-70/41A ... Air Piston Kit ( Includes Air Pistons,air fitting and Shortened Springs, uses caps from AS Trees) 2013 and down
- BB/AR-70/41S ... Air Piston Kit ( Includes Air Pistons,air fitting and Shortened Springs and caps to fit stock trees) 2013 and down
- BB/AR-70/41P ... Air Piston Kit ( Includes Air Pistons and air fitting uses caps from AS Trees) 2013 and down
- BB/AR-70/49A ... Air Piston Kit ( Includes Air Pistons,air fitting, uses caps from AS Trees) 2014 and up 49mm
- BB/AR-70/49S ... Air Piston Kit ( Includes Air Pistons,air fitting and Caps to fit stock trees) 2014 and up 49mm



## Mach 8 Inverted Fork

The Mach8 Performance Touring Front End utilizes our patented perimeter valve technology and fits a 21", 23", 26", 30" or 32" front wheel on your 97 to 2018 touring HD.

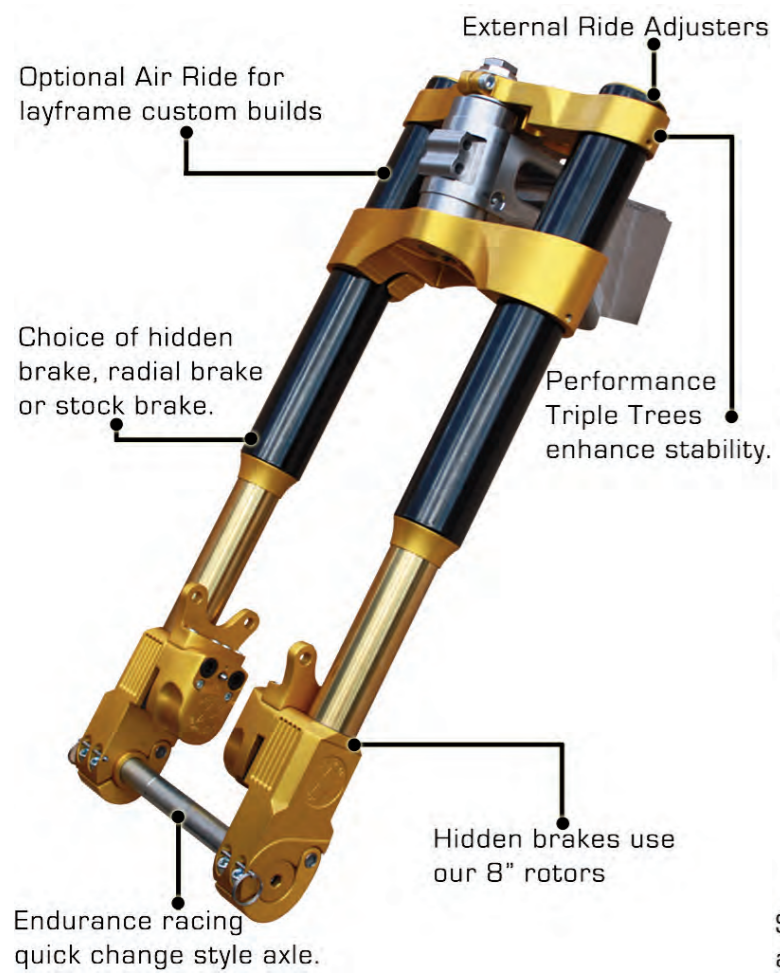

## Dragon Springer

The D-66 Dragon Spring is the most sophisticated springer front end available. Made to fit 26" and 30" wheels with Bolt On Neck Kits. Get modern performance and medieval style.

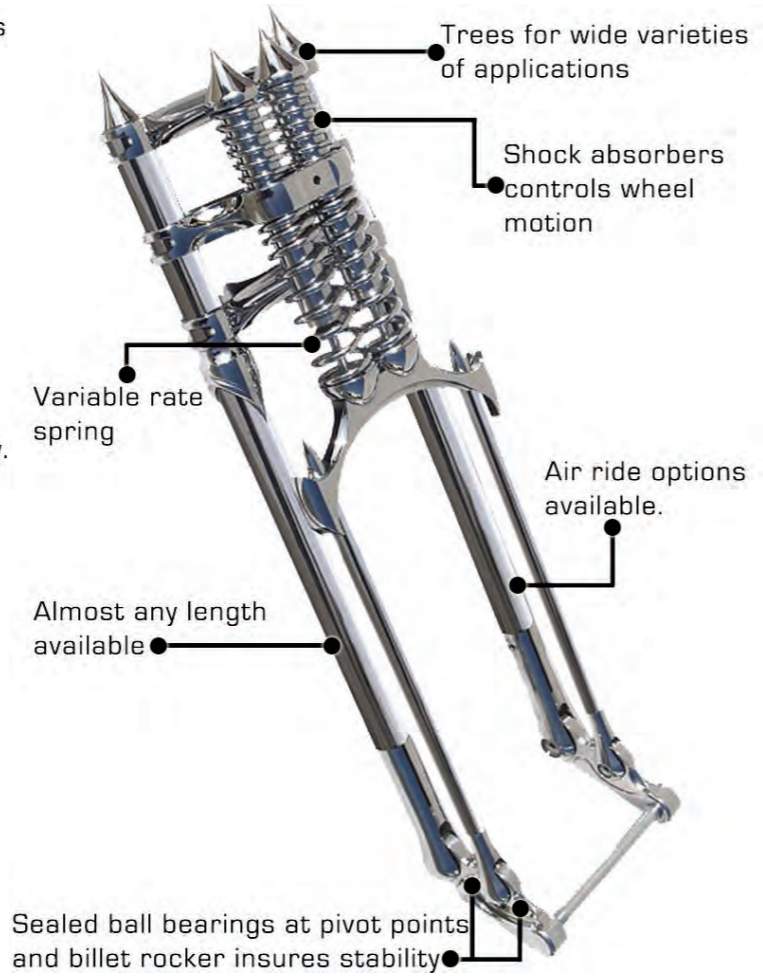

## B-17

The B-17 fork utilizes our patented perimeter valve technology which gives you the smoothest ride of any fork and features hidden brake lines running inside the fork tube, hidden axle, hidden steering stem and hidden headlight mount. Available in raw, chrome, polish, black, titanium and brass monkey. Additional Air Ride option available too.



## Vampire Fork

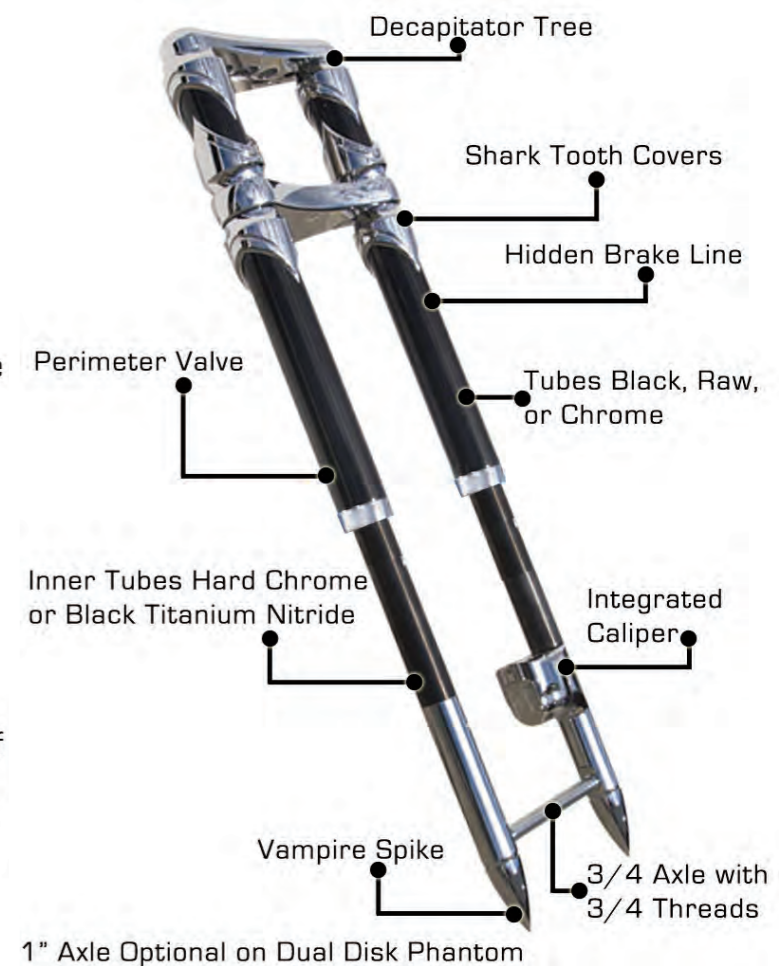



# ARLEN NESS



He is best known for his customized choppers and hot rods. His first customs were made in the garage of his home in San Leandro, California, but by the early '70s he had moved to a storefront on East 14th Street. Ness is recognized for his unique painting style and for developing a line of custom motorcycle parts. His popularity grew as he built new custom bikes and then had them displayed on the bike show circuit and featured in motorcycle magazines. After more than three decades of custom bike building and developing his business, Arlen Ness, Inc. moved to a Dublin, California facility which included a museum featuring more than 40 of his custom motorcycles. The museum displays his Untouchable, the twin motor. His son, Cory Ness, has worked with Arlen for more than 30 years and now runs the day-to-day business operations at Arlen Ness, Inc.





# ARLEN NESS

## ProCross

Race inspired design with extreme attention to detail. Lightweight yet engineered to perform and handle anything the road wants to throw at you. Although the inspiration came from the racetrack it didn't mean we didn't spend countless hours sculpting each "spoke" to ensure it rode the fine line between race and luxury styling.

Precision machined from radial forged 6061-T6 aluminum for maximum road durability  
Structurally tested to meet or exceed DOT, JAS and TUV international load ratings  
Hub design features a cartridge type hub that includes both bearings that are pre-set and ready to install in minutes

Available in chrome or black anodize finish  
Matching floating performance rotors are also available

### Cartridge Hub Features

These billet aluminum wheel hub kits are designed to work with Arlen Ness forged aluminum rims  
Cartridge design hub features both wheel bearings pre-set in one hub for optimum radial and lateral runout accuracy  
Hub kits mount to your Ness rims in minutes and offer excellent flexibility for factory or custom application  
Lightweight coped design provides form and function  
All hubs are available in chrome or black anodized finishes



# ARLEN NESS

## NEW WHEEL PROGRAM

### FLARE 5

The FLARE 5 represents the next level in motorcycle wheel design. Sculpted CNC features extend from the axle all the way to the outer edge of the rim lip. Its multi-piece design features a radial forged rim, forged hub covers, hidden cartridge hub and spoke mounted 14" rotors for a combo never before seen in the v-twin aftermarket. FLARE 5 is the first design in the Ness premium wheel series.

Precision machined from radial forged 6061-T6 aluminum for maximum road durability  
Structurally tested to meet or exceed DOT, JAS and TUV international load ratings  
Hidden hub design features a single piece cartridge type hub that includes both pre-set bearings

Forged hub covers are specially designed to bring full 3D styling from the bearing in the hub to the outer edge of the rim lip  
Available in chrome or black anodize finish  
Matching floating performance 14" rotors are also available

### Cartridge Hub Features

These billet aluminum wheel hub kits are designed to work with Arlen Ness forged aluminum rims  
Cartridge design hub features both wheel bearings pre-set in one hub for optimum radial and lateral runout accuracy  
Lightweight design provides form and function all while being hidden from view



### Front Wheel Sizes available

- 18 x 3,5"
- 21 x 3,5"
- 23 x 3,5"
- 26 x 3,5"

### Rear Wheel sizes available

- 17 x 6,25"
- 18 x 3,5"
- 18 x 5,5"

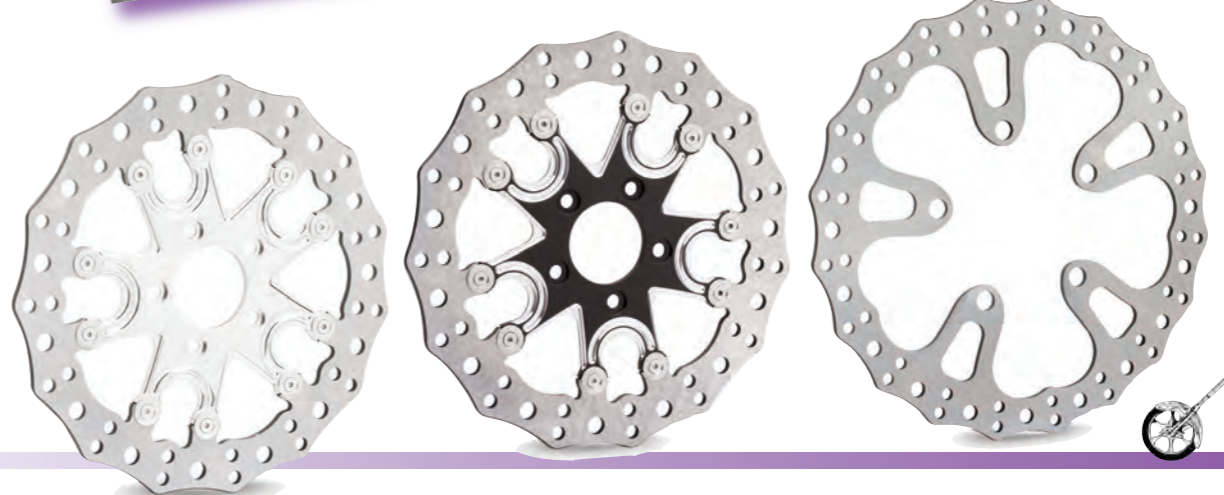
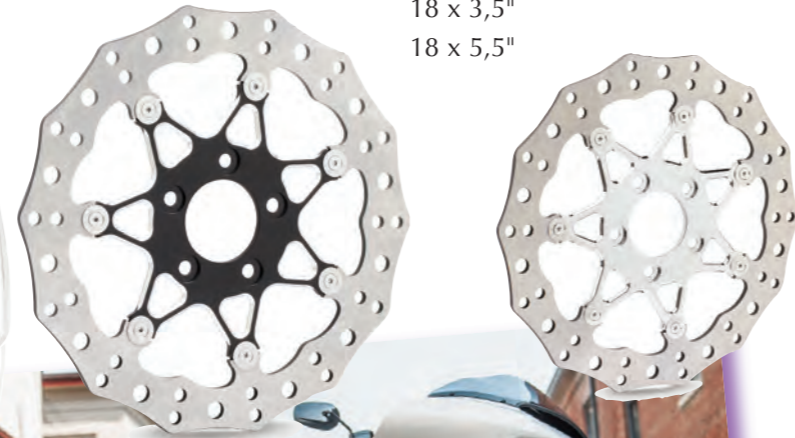

Assorted rotors and pulleys also available in the design of the wheels





# ARLEN NESS



## A wide range of products

make for your HD, Indian or Victory motorcycles  
by the innovative Arlen Ness company  
All the parts offered in their catalog available with various finishes !.

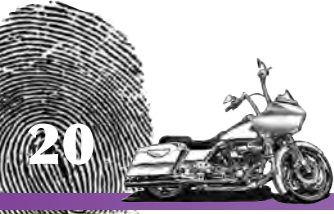



# Arnott

MOTORCYCLE AIR SUSPENSION

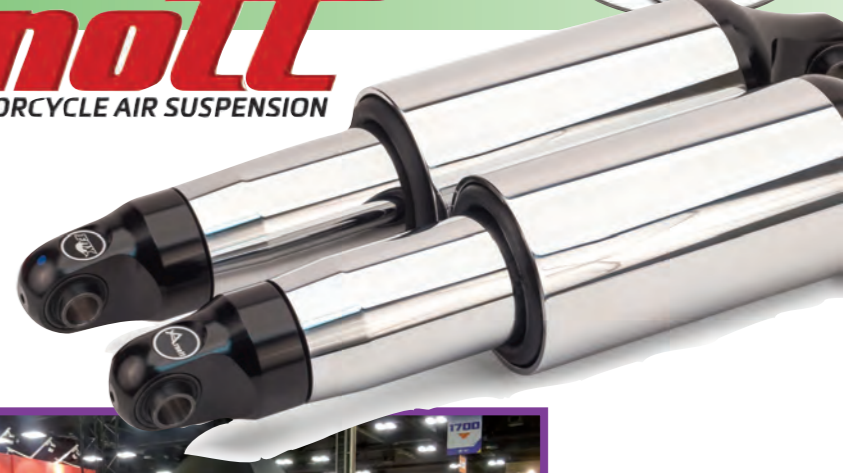

# Arnoll

MOTORCYCLE AIR SUSPENSION

2015 marked Arnott's 25th Anniversary of manufacturing quality aftermarket air suspension products for luxury vehicles and motorcycles. In 1989, at the age of twelve, Adam Arnott developed a fascination for automobiles, and motorcycles, spending most of his free time tinkering in his parents' garage in Punta Gorda, Florida. His father, Donald Arnott, an avid motorcycle rider, immediately recognized his son's mechanical aptitude and encouraged young Adam's interest. The next year the pair began traveling throughout Florida, repairing automobile air suspension problems, often for little or no fee. Adam's passion, coupled with Donald's selfless satisfaction of helping others, laid the foundation for what would become the most successful, advanced, and innovative air suspension products manufacturer in the world.







# ARNOTT SUSPENSION

Air Ride Air Suspension Kits for: Harley-Davidson, Honda, Indian, Kawasaki, Suzuki, Victory, and Yamaha. Enjoy all the benefits of Arnott TruAIR technology. 1-button lowering for your motorcycle with up to 3" shock travel. All Arnott® products are easy to install with Online Manuals and Instructional Videos on Youtube. You'll receive less painful bottoming and a smoother more comfortable overall ride, plus you'll be able to rest on-the-fly while stopped or maneuver better for easier parking.

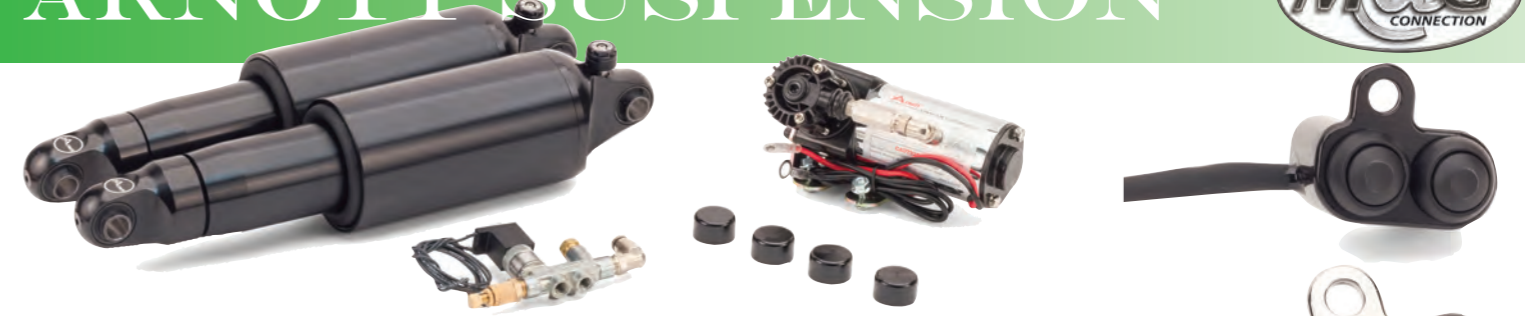

HARLEY-DAVIDSON  
SOFTAIL

**TruAIR Technology**  
Unlike many competitors, Arnott's TruAIR technology is true adjustable air suspension, not simple air cylinders, 'air-assisted' shocks or automotive castoffs. Arnott's TruAIR Onboard Adjustable Air Suspension technology provides superior comfort, adjustability and great looks. Arnott kits offer fast, on-the-fly adjustable air spring firmness using a powerful onboard compressor.

**Comfort**  
Arnott motorcycle air suspension kits are fully adjustable based on height and weight so riders can rest flat-footed while stopped and enjoy a more comfortable ride on long-distance runs, riding two-up or with luggage.

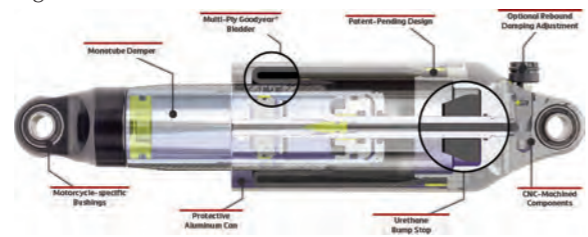

**Safety**  
Arnott kits are designed and tuned specifically for motorcycles. Even if the air spring bladder is fully deflated, the fender won't touch the tire unlike automotive-designed shocks installed on motorcycles. Since Arnott's TruAIR Suspension is true onboard adjustable air suspension, it helps to significantly reduce issues seen in air cylinders or 'air-assisted' shocks such as bouncy rides and the danger during evasive maneuvering or hard riding.



**Tuning**  
Conventional spring and shock tuning can be tedious and time-consuming.. taking days or even weeks. With Arnott's onboard adjustability, tuning air suspension to your individual taste often is reduced to just a few minutes.

**Handling**  
Coupled with Arnott onboard adjustability, setting your suspension to specific drive conditions is quicker and faster, improving the overall ride.

**Customization**  
By adjusting air pressure and shock valving, your ride can be smooth and comfortable, firm and rigid, or somewhere in the middle. What makes Arnott air suspension unique is that you can alter the motorcycle's ride performance base on desired settings, all with existing components.

**Pressure Gauge for Touring Series**  
Arnott now offers an economical way to monitor the air pressure in your air suspension system. Kit comes standard with a black powder-coated mounting bracket. This easy-to-install assembly mounts on the left side of the bike, in front of the seat. No drilling required.

- Features:**
- 1.5" Diameter Gauge
  - White Easy to Read Face
  - Easy to Install
  - Mounting Bracket with Chrome Finish
  - Engineered and Made in USA
- Includes:**
- 160 PSI Gauge
  - Mounting Bracket
  - 2 Air Fittings
  - 3' Nylon Air Tubing

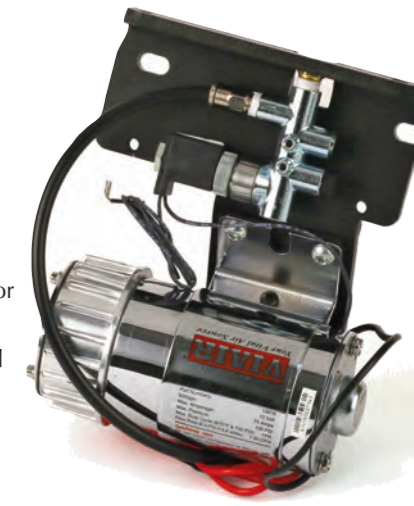



# ARNOTT SUSPENSION



Model	Years	Shock	Length	Finition	Adjust Rebound	Part Number
Dyna®	1991-2007	Bilstein	Short 11.6"	Black	No	ARN/9008-BS-B
Dyna®	1991-2007	Bilstein	Short 11.6"	Chrome	No	ARN/9008-BS-C
Dyna®	1991-2007	Fox	Standard	Black	Yes	ARN/MC-2995
Dyna®	1991-2007	Fox	Standard	Chrome	Yes	ARN/MC-2997
Dyna®	1991-2007	Fox	Standard	Black	No	ARN/MC-2998
Dyna®	1991-2007	Fox	Standard	Chrome	No	ARN/MC-2999
Dyna®	2008-2017	Bilstein	Short 11.6"	Black	No	ARN/9030-BS-B
Dyna®	2008-2017	Bilstein	Short 11.6"	Chrome	No	ARN/9030-BS-C
Dyna®	2008-2017	Fox	Standard	Black	Yes	ARN/MC-3100
Dyna®	2008-2017	Fox	Standard	Chrome	Yes	ARN/MC-3101
Dyna®	2008-2017	Fox	Standard	Black	No	ARN/MC-3102
Dyna®	2008-2017	Fox	Standard	Chrome	No	ARN/MC-3103
Softail®	2001-2017	Fox	Standard	Black	No	ARN/MC-2908
Softail®	2001-2017	Fox	Standard	Chrome	No	ARN/MC-2909
Sportster®	2005-2008	Bilstein	Short 11.6"	Black	No	ARN/9009-BS-B
Sportster®	2005-2008	Bilstein	Short 11.6"	Chrome	No	ARN/9009-BS-C
Sportster®	2009-2017	Bilstein	Short 11.6"	Black	No	ARN/9047-BS-B
Sportster®	2009-2017	Bilstein	Short 11.6"	Chrome	No	ARN/9047-BS-C
Touring Series	1990-2008	Bilstein	Short 11.6"	Black	No	ARN/9023-BS-B
Touring Series	1990-2008	Bilstein	Short 11.6"	Chrome	No	ARN/9023-BS-C
Touring Series	1990-2008	Fox	Standard	Black	Yes	ARN/MC-2914
Touring Series	1990-2008	Fox	Standard	Chrome	Yes	ARN/MC-2915
Touring Series	1990-2008	Fox	Standard	Black	No	ARN/MC-2916
Touring Series	1990-2008	Fox	Standard	Chrome	No	ARN/MC-2917
Touring Series	2009-2017	Bilstein	Short 11.6"	Black	No	ARN/9048-BS-B
Touring Series	2009-2017	Bilstein	Short 11.6"	Chrome	No	ARN/9048-BS-C
Touring Series	2009-2017	Fox	Standard	Black	Yes	ARN/MC-2904
Touring Series	2009-2017	Fox	Standard	Chrome	Yes	ARN/MC-2905
Touring Series	2009-2017	Fox	Standard	Black	No	ARN/MC-2906
Touring Series	2009-2017	Fox	Standard	Chrome	No	ARN/MC-2907
Tri-Glide	2009-2017	Fox	Standard	Black	No	ARN/MC-2918
Tri-Glide	2009-2017	Fox	Standard	Chrome	No	ARN/MC-2919
V-Rod®	2007-2017	Fox	Standard	Black	Yes	ARN/MC-3110
V-Rod®	2007-2017	Fox	Standard	Chrome	Yes	ARN/MC-3111
V-Rod®	2007-2017	Fox	Standard	Black	No	ARN/MC-3112
V-Rod®	2007-2017	Fox	Standard	Chrome	No	ARN/MC-3113



Indian and Victory kits are also available ... just ask to get your quotation



Bilstein Kit Black

ARN/MC-2913  
Victory Bagger/Touring  
2010-2017 Blk

**Harley-Davidson®**  
Dyna® Softail® Sportster® Tri Glide® Touring Series V-Rod®  
**Indian®**  
Cruisers, Baggers & Touring Scout® & Scout Sixty® w/o ABS Scout®  
& Scout Sixty® w/ABS  
**Victory®**  
Baggers & Touring Cruisers



Bilstein Kit Chrome



To place order or get quotation on our web site with your login info ... Here's the part number with application chart !

New applications for Softail 2018 :  
ANR/MC-3208 ... With switch Black    ARN/MC-3209 ... With switch Chrome

[www.arnottcycles.com](http://www.arnottcycles.com)





# BAD DAD®



WWW.BADDAD.COM



## BAD DAD BAD



**FULL BOLT-ON PARTS**  
BAD DAD.COM

**SUMMIT FENDER WITH 902 LIGHTS**  
REPLACES THE STANDARD FENDER AND GUARDS THE MOTORCYCLE'S REAR LIGHTS. PERFECT FOR TOURING. AVAILABLE IN 10 COLORS. SEE US AT THE SHOW!

- ✓ BOLT-ON KITS
- ✓ PRE-DRILLED & PRE-FIT PARTS
- ✓ AVAILABLE FOR TOURING & SOFTAIL
- ✓ IN-STOCK PARTS FOR QUICK SHIPPING
- ✓ DEALER PRICING AVAILABLE



*Bad Dad is committed to making high quality parts that allow our customers to create the custom motorcycles they have envisioned building.*

*Bad Dad focuses on designing products that enhance the aesthetics of the motorcycle while still maintaining the motorcycle's original functionality. It is Bad Dad's goal to create bolt-on custom parts that look as great as they perform and to provide our worldwide customers with the highest level of customer service.*

*Bad Dad's product line includes front & rear fenders, custom saddlebags & side covers, gas tank & dash panels, floorboards & forward controls, and exhaust & air cleaner system.*

*Our entire product line allows our customers to transform their motorcycles into the custom motorcycle they want to own & ride. Bad Dad's History.*

*Bad Dad opened early in the year 2000 as a small division of Derk Hinsey's collision center, Hinsey's Pro Paint, which was founded in 1979. Today, Bad Dad combines Derk's thirty-five plus years of bodywork experience with some of the 21st century's newest technology to produce the complete line of Bad Dad original parts.*





# BAD DAD



## A good reputation is something to live up to, not lean on.

### Bad Dad's History.

Bad Dad opened early in the year 2000 as a small division of Derk Hinsey's collision center, Hinsey's Pro Paint, which was founded in 1979. Today, Bad Dad combines Derk's thirty-five plus years of bodywork experience with some of the 21st century's newest technology to produce the complete line of Bad Dad original parts.

### Quality Parts for Building Quality Motorcycles.

We are continually using leading technologies to create new products that meet the needs of our customers. Each new improvement and every new design is passed along to our great customers who use our custom parts on their motorcycles. We genuinely appreciate the loyalty & support of our customers who choose to use our designs for building their custom projects.

### Made in the USA.

Every one of Bad Dad's custom parts are proudly designed and made in the USA. Over 90% of Bad Dad's products are made in Northeast Indiana, and over 98% of Bad Dad's products are made in Indiana, Illinois, Ohio, or Michigan.



### Bad Dad's Speaker Lid Kit for Road Kings & Softails

Upgrade your Road King or Softail with Bad Dad's Complete Speaker Lid Kit. This kit puts high-powered speakers directly into the hard saddlebags on your Road King or Softail and allows easy access to your favorite music through the system's Bluetooth controller. This complete kit includes speaker lids, grilles, 200+ watt speakers, 400-watt amp, wiring harness; Bluetooth controller, and all mounting hardware & seals. Bad Dad's Complete Speaker Lid Kit is available with or without LED taillights flush mounted into the speaker lid's custom bodyline.



### Bad Dad's Stretched Side Covers

Stretch that bagger a little further with Bad Dad's Stretched Side Covers. These snap-on side covers are a complete replacement with no need for bonding or gluing- just press them into place! Bad Dad's Stretched Side Covers are made from thick hand laid fiberglass and feature mounting pins that make these covers a snap-on replacement. The side covers are then finished in a smooth gel coat that is easy to prep & paint



### Bad Dad's Classic Series Chin Spoiler

Add some extra color to the front of your bike with Bad Dad's Classic Series Chin Spoiler. Bad Dad's custom chin spoiler is designed to fill the gaps between your bagger's frame. Bad Dad's Classic Series Chin Spoiler is a great bolt-on part for all 1997-2016 Touring models and fits with all OEM oil coolers. This custom chin spoiler fits all wheels & fender combinations from 16" - 30" wheels, including both raked and non-raked bikes. All mounting hardware is included.

### Bad Dad All-in-One Summit Rear Fender

Stretch out the back of your bagger with Bad Dad's All-in-One Summit Fender. This bolt-on replacement fender is available with a custom taillight that improves your bike's run light, brake light and turn signals, and the Summit Fender is a great fit with any of Bad Dad's Stretched Saddlebags.

This composite fender comes pre-drilled for easy installation and is finished in a blemish free gel coat. Bad Dad's Summit Rear Fender is available for both Touring and Softail models and works with all of your detachable docking hardware.

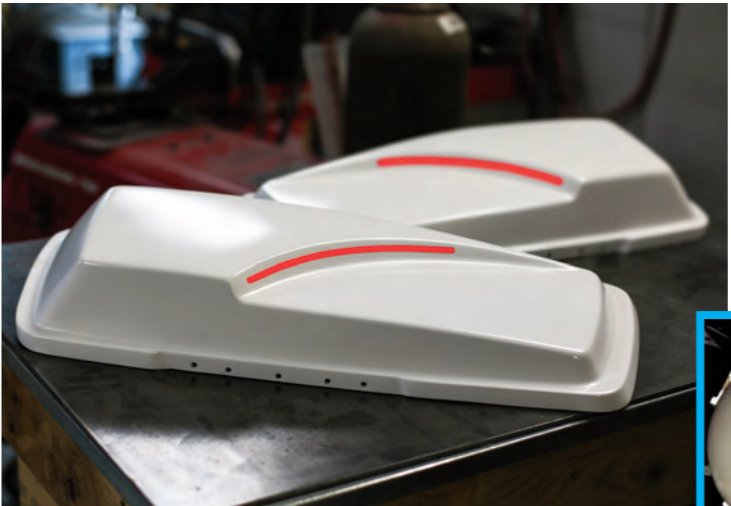

### Bad Dad's Competition Series Saddlebag Lids with LEDs

Bad Dad now offers its popular Competition Series Saddlebag Lids with flush mounted LEDs. This custom saddlebag lid features a custom raised bodyline that looks great on any bagger project. These custom lids are available with or without LEDs built into the custom bodyline. The Competition Series Saddlebag Lids are a direct bolt-on replacement lid for any 1993-2013 saddlebag. New weatherstrips and lid hardware are included with your new lids. .

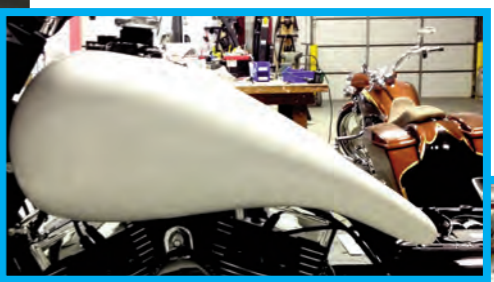

Classic or Competition Stretched Tank Covers



### Bad Dad's Cooley Bars

Need a cool set of drag bars for your Road King or Softail? Bad Dad's Cooley Bars are the perfect fit. Bad Dad's Cooley Bars feature DOM mandrel bent 1-1/2" tubing for a great look and easy internal wiring. These custom handlebars are master cylinder & fly-by-wire ready, and are available in raw, gloss black powdercoat & chrome finishes.



905 Driver Floorboard ... exist also for passenger



### Bad Dad's Forward Controls

Clean up your factory brake & shift assemblies with Bad Dad's Forward Control Kit.

Bad Dad's Forward Controls are custom machined from 6061 billet aluminum and finished in your choice of black or chrome. This custom kit includes the entire shift arm & brake arm assemblies, custom inner shift arm, rider floorboards & your choice of passenger floorboards or passenger pegs. Bad Dad offers several custom floorboard styles which can be





**Bad Dad's Competition Series Raked Fairing ... with or without Flushing LED**  
 Finish the 26" wheel upgrade on your Street Glide project with Bad Dad's Competition Series Raked Fairing. This fairing is designed specifically for raked bikes with 26" front wheels. This custom fairing features contoured custom bodylines and properly aligns your Street Glide's headlight after raking the bike. Bad Dad's Competition Series Fairing is a direct bolt-on replacement fairing that is pre-drilled & pre-fit to use all your original hardware, including the original inner fairing, windshield, and headlight. This fairing fits all 1997-2013 Touring models and is available with or without flush mounted turn signals.



**Bad Dad's 957 and 992 Taillights**  
 Bad Dad now offers two custom taillight options to light up your bagger. Both Bad Dad's 957 Taillight and 992 Taillight designs are great ways to add a custom touch to your custom project. These custom taillights are CNC cut from billet aluminum and feature incredibly bright LEDs. Both designs are available in black or chrome. The 992 is also available with Red and amber turn signal function



**Bad Dad's Competition Series Tour PAK ... with or without Flushing LED**  
 Your bagger is the ideal touring machine. Now you can carry even more stuff and add more lighting to your bike with Bad Dad's Competition Series Tour Pack. This complete assembly includes the lid, lower base, complete hinge & latch assembly, and new weatherstrip. The lid & base are injection molded for a completely smooth interior and each Tour Pack is available with and without taillight options in the trunk lid. All holes are pre-drilled & pre-fit and the exterior is finished in a smooth, blemish free gel coat. Just add paint!



957 TAILLIGHTS



992 TAILLIGHTS

**Bad Dad 975 Crash Bar in Chrome or Black**



BADDAD.COM

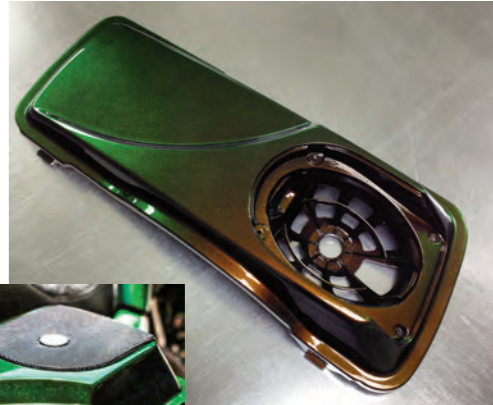

**Bad Dad's Competition Series Speaker Lids**

Bad Dad's Competition Series Speaker Lids are now available for all 1993-2013 Touring models. This custom saddlebag lid features a smooth contoured bodyline. The Competition Speaker Lid is designed to use any 5x7 or 5x8 speaker, including the Boom Audio system and J&M's Rokker Series. These custom saddlebag lids are made with injection technology for a precise fit with new weatherstrips & mounting hardware.



**Precision Fit Fenders from Bad Dad**  
 Your custom project wouldn't be complete without the perfect fender to show off your new wheels. Bad Dad is currently using the precision technology of RTM injection for many of its custom front fenders. The RTM injection process allows Bad Dad to provide you with a fender that is super strong, precision fit, and features a smooth exterior and interior that your body man will love!  
 Bad Dad's RTM fenders are available for 21", 23" & 26" front wheels, and available in both a classic FL style design and also the streamlined look of the Wrap Fender. All of Bad Dad's front fenders are pre-drilled and pre-fit for easy installation and include chrome mounting spacers.



**Bad Dad Long Strokes Exhaust**

Bad Dad's Long Strokes Exhaust Pipes are the right stretched pipes for your stretched bags. These chrome slip-on mufflers are angle cut and elongated to show the perfect amount of chrome from the back of your stretched bags. Bad Dad's Long Strokes fit 1995 to current year Touring models and have a deep idle with moderate exhaust note that won't upset the neighbors but will sound as good as your custom bagger looks.



**Bad Dad Turn Down Exhausts**

Bad Dad's new Turn Down Exhaust is the cleanest exhaust setup for any stretched bag project with no rear exhaust exits. These slip-on mufflers allow your exhaust to exit underneath the saddlebag, which is perfect for any project using Bad Dad's Competition Series Saddlebags or classic Stretched Bags. These custom slip-ons feature a built-in baffle to create a great classic sound. Pipes fit 1995-2018 Touring models with a dual headpipe. This is a great exhaust pipe for any Street Glide, Road Glide, Electra Glide, Ultra Classic, or Road King project.





# BAKER DRIVETRAIN

Wielding American power to the pavement for all

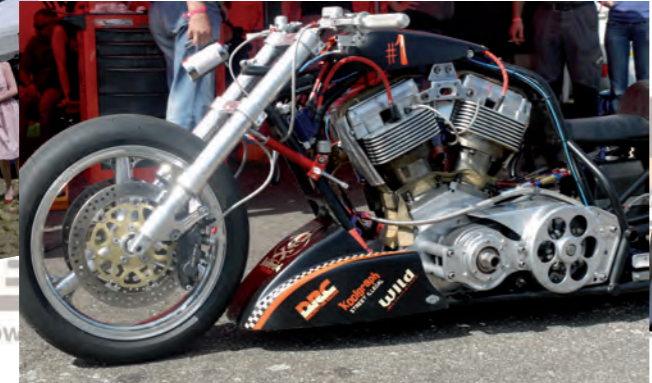
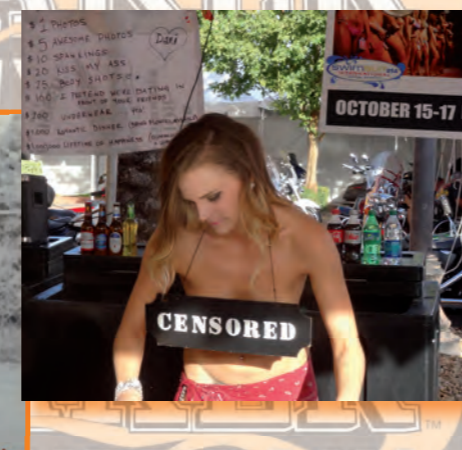
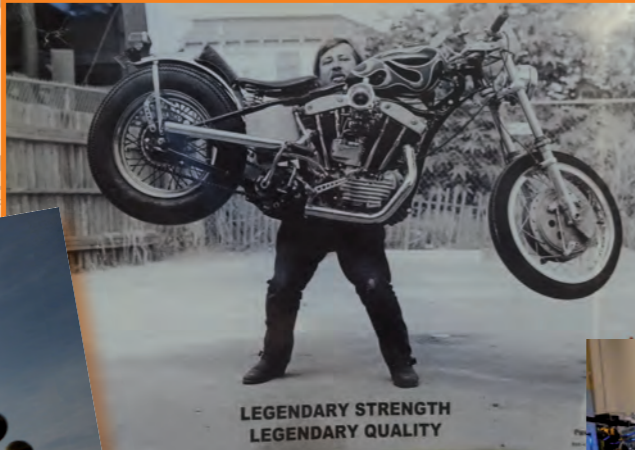

When it comes to Vivin transmissions nothing beats Baker and their commitment to provide the best to owners and dealers. All American made with no compromises, no cheap imported parts are involved in the production of this company dedicated to bringing you stronger and smarter upgrades and complete assemblies to fill whatever need you have for your bike.

They have even chosen the location of their facilities to be in the place of America where industry means mechanical engineering.

There was time when some cheap import gears where the only solution to rebuild something like a 4 speed tranny kicker system and you always ended with mashed gears in a short period of time where the stock ones took years to reach such a condition. This is an example of what you can now avoid thanks to Baker.

If you miss a 6th in your 5 speed Sportster transmission just look into the offer and choose from different ratio and even the shifting pattern!

Need more to be convinced? Just take a look at the impressive range of products Baker has for you.

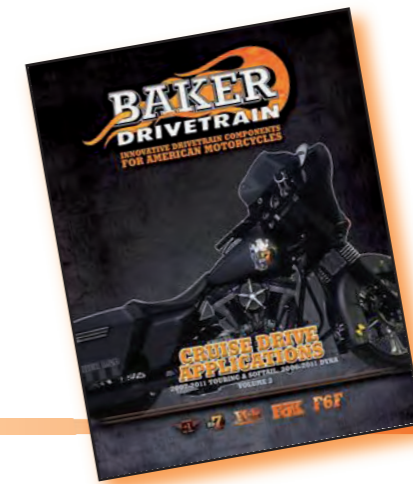



# BAKER DRIVETRAIN



### Shift Fork Kit

Shift Fork Kits include all three forks and are a direct replacement for the standard O.E. 5-speed forks but with much needed improvements over the stock design. Cross section is three times thicker than stock.



### Compensator Kit

BAKER Compensator Kit for 2007-Later Big Twins! The BAKER 630-67K Compensator Kit features improved function, quieter operation, and extended durability over the stock factory configuration.



### BAKER 6 into 4

Made to satisfy the old school tendencies while providing the ability to run reasonable RPM's at highway speeds. Panhead and Shovelhead riders will love the ability to ride hard with their friends on late model bikes.



### BAKER 4-Speed Trannies

BAKER 4-speed trannies, available with ratchet top or jockey top lids. The external architecture of cast (A356-T6) 4-speed transmission case was modeled after factory cases to capture all the details and character of the original design. But include many functional upgrades to address shortcomings of the original design like leaks, serviceability, and durability.

### Baker Splined Shovel Clutch

The splined Shovel clutch kit retrofits and upgrades the stock tapered mainshaft and clutch to a modern 18 tooth spline configuration. Kit includes a fully assembled clutch and splined 4-speed mainshaft to retrofit stock 1970-E84 Big Twins. The clutch is based off of Baker 9-plates clutch used on 1990-2006 applications and fits in the stock Shovelhead primary housing and TTP. We offer 35, 36, 37, and 38 tooth clutch sprockets with our clutches to dial in your overall gear ratio. 18 tooth mainshaft installs into the stock 4-speed transmission just like stock.



### Baker Bully Primary

The Bully Primary Cover will add the style and cool factor to your 2007 & later Touring model that the stock primary cover could not. With the introduction of the stock 6 speed on the 2007 Touring models also came a completely new primary assembly. This new primary design got smoother and thus more boring than the previous version. Being the biggest single piece of architecture on the left side of the motorcycle, it is just begging to be upgraded and replaced. We added a motor sprocket cover, inspection cover and what we call the bellhousing around the clutch to break up the large mushy surface area of the stock unit. Adding separate covers also opens up the possibilities when it comes to customizing the aesthetics to meet your demands.

### Baker Kicker Gears

There was a time when you could only purchase some Taiwanese shit kicker gears because nobody made them in the USA anymore. So we tooled up our own right here in Michigan, fuck it. They come standard on all BAKER 4-speeds, 6-into-4's, and kicker kits. Take a pair of imported shit gears and roll the teeth together; they roll like a mismatched pair of gears and are dangerous to have inside your tranny. Classic Kicker Gears roll smooth as glass. They're not cheap, but they are the last set you will have to buy.

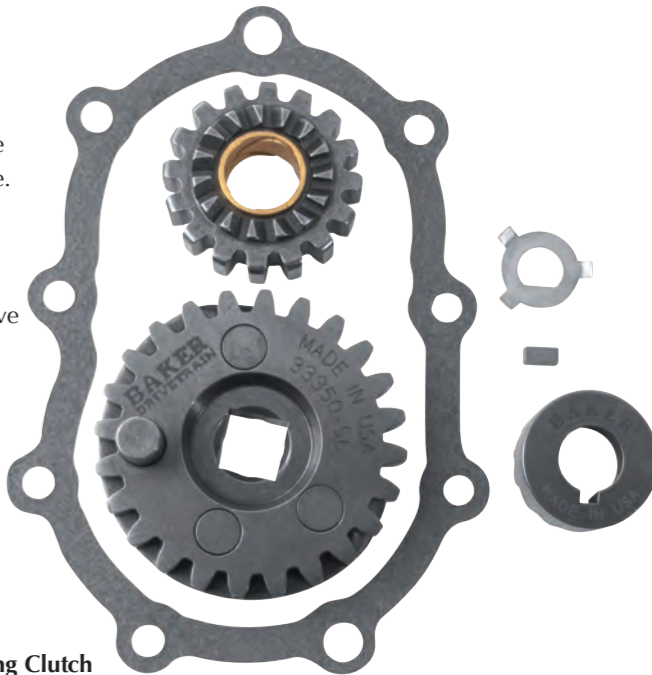

### Baker King Kong Clutch

The goal was to implement the biggest diameter clutch plates that would fit underneath the starter ring gear minor diameter. We found the biggest ones in a Cadillac 5-speed automatic tranny so we designed a clutch around 20 of these massive plates. 1990-2006 Big Twins (except 2006 Dyna)

### Baker 5 Speed Shift Kit

The design principles that made our Six-Speed Overdrive shift so smooth were applied to create a shift drum/pillow block kit that will bolt on to any 5-speed and give super smooth and precise shifting. The pillow blocks included with the kit are machined from our 6061-T6 extrusion stock for a significant increase in strength over stock. The roller shift drum features the same enhancements as the replacement 5-speed drum shown, as well as a revised detent profile for roller compatibility.





# BAKER DRIVETRAIN



### Baler 1.5 Oil Pan

Today's Big Twin engine makes a lot more power and a lot more heat than its predecessor of 20 years ago. More torque equals more heat, but that's just part of the story. The engine oil capacity of 4.0 quarts is unchanged from 1993 to present even though modern engines make a lot more power and a lot more heat. Engine oil does two things. It lubricates metal-on-metal interfaces and carries heat away from hot spots like cylinder heads and the underside of the pistons. So BAKER's +1.5 quart oil pan was designed to lower engine oil temperature by using a larger volume of oil to carry heat away from the hot engine.



### Baler OD 6

This is the ORIGINAL 6-speed design that revolutionized the American V-Twin industry. Yet, it's still the best overdrive 6-speed built to this day. Our OD6 is built to comfortably handle the power from today's big-inch motors. This transmission is rated for motors putting out up to 165ft/lbs of continuous use. It is available as a complete transmission with a wide variety of case options and configurations, or as a builder's kit for your stock case application, which requires little to no modification. The BAKER OD6 is available with many optional gear ratios to match your engine torque and riding style.



### Armored Attitude Adjuster

Prevent damage to your motorcycles left side motor case bearings, inner primary bearings, clutch hub bearings and transmission output gear bearings.

If you have a 2006 or later Dyna, or a 2007 and later Softail/ Touring bike you know the issues that come along with the stock auto chain tensioner. At the first moment that the chain has any slack in it, the auto tensioner ratchets the shoe up another notch. Now one notch is not going to be an issue, but the tightening never stops and this causes several problems. Our manual chain tensioner allows you to set the chain to the proper 5/8"-7/8" (cold) freeplay, and never have to worry about it being too tight

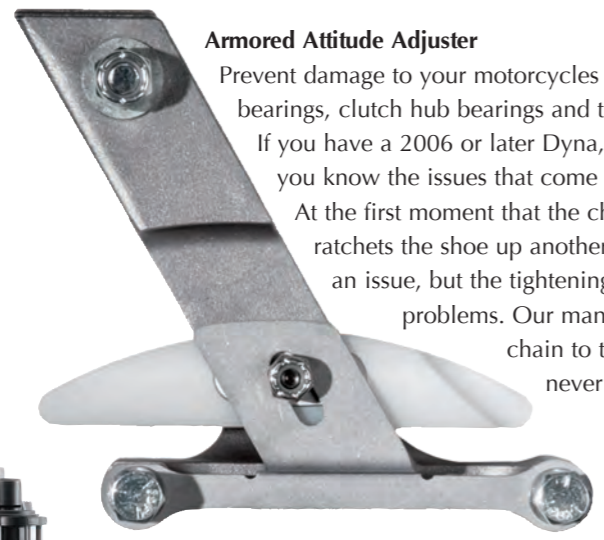

### Baker Grudge Box

Built to take high horsepower abuse found in late model H-D performance applications while providing elegant shift precision.

Transmission Configurations:

GrudgeBox Street - Straight cut 1st, 2nd and 3rd gears, helical 4th, 5th and 6th designed and geared for everyday highway riders with modern H-D horsepower.

GrudgeBox Strip - Straight 1st, 2nd 3rd, 4th, 5th and 6th gears, design and geared for performance buffs, racers and speed freaks seeking negligible power loss.

Fitment

2006-later Dyna

2007-later Softail & Touring



### Baker DD7

The DD7 upgrades any existing 2006-later big twin 6 speed to a full 7 speed transmission. It is more than just another gear added, the 7th gear enables the motorcycle to now make full use, by way of gear ratio management, of the torque and power put out by the new 96 CI and 110 CI. We did not make this transmission a deep overdrive, rather we shortened 1st gear and tightened up the gears to deliver the riding experience that you were after when you bought your bike. The gear ratios leave you the rider, with the experience of smooth, crisp, continuously pulling acceleration from 1st all the way through 4th gear. Then you are able to start getting into the cruising portion of the program in gears 5th-7th. No big drops in RPM from one gear to the next or lugging the motorcycle off of a stop light, just smooth, uninhibited acceleration.

We did not stop at just fixing the gear ratios. We improved the smoothness and crispness of the shifting by reducing the mainshaft mass by only having 1st gear be a part of the shaft, rather than 1st-4th gears like on the stock unit. We ditched the stock detent arm and spring assembly from the door in favor of a Linear Detent that decreased friction while increasing smoothness when coupled with the all new shift drum design. We have tightened up the dog teeth on the gears to prevent the loud clacking noise that accompanies every shift on the factory 6 speed.

Through the use of a billet bearing door, 28% wider bearings in the door, steel bearing retainer plates and full width gears, the durability and strength of our unit is a drastic improvement. By utilizing fully diamond ground, helical gears in 1st & 4th-7th we are able to deliver a much quieter riding experience. While 2nd and 3rd gears are diamond ground, spur gears to handle the peak torque that is reached in that range.



### Baker Street Clutch

The 9-plate clutch is the competitively priced smaller brother of the King Kong Clutch. A must have for all 1990-93 Big Twins, and 1994-06 Big Twins with a 9 tooth pinion. This clutch comes as BAKER Drivetrain's standard for premium. It has a one piece basket, which is 23% larger than stock, and a hard anodized hub for increased strength and durability. We moved the friction material towards the outer diameter of the plate, which increases torque capacity and reduces heat build-up, all resulting in a longer clutch life.

Standard diaphragm spring installed and sent with a separate heavy duty rated spring. If you have a 1994-2006 (except 06 Dyna); 102 tooth clutch basket, you will need to purchase the AC/DC 9-Tooth starter pinion.

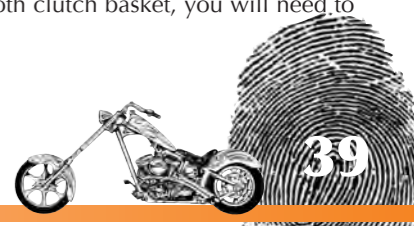





fabricant français de freins depuis 1985

Disques, Etriers, Maître cylindres, Leviers d'embrayage

Kit complet, Alu taillé masse, Pièce sur mesure

*Beringer is a French human scaled company that designs since 30 years motorcycles brakes with a high quality & performance spirit.*

*Our products are internally manufactured within the highest Aluminium qualities and anodized, each unit is assembled by ourselves.*

*Beringer participation among several championships together with our 10 owned patents abled us to offer you the best braking products in terms of esthetic, precision, comfort, power & control.*





# BERINGER BRAKES



Our products ranges covers all brands & motorcycles styles from the 70's up to now.  
 Due to our large products variety you will be able to customize your motorcycle in a unique design  
 If you have a special request , our passionate team will be pleased to assist you !



Development of BERINGER® motorbike and automotive brake systems continues with new headquarters and production plant.  
 The new site with 1500m2 of modern production capacities for motorbike and automotive brake systems is operational.  
 The new team is now able to ensure a better reactivity.  
 More than 10 patents and the experience of an exceptional team have allowed BERINGER® to take a decisive technological lead.  
 BERINGER ® is also the engineering of any braking system. BERINGER company has always invested heavily in innovation: more than 10% of its turnover is spent each year in R & D department with more than 10 worldwide patents

BERINGER® manufactures racing brakes for motorcycles with a quality and performance spirit unchanged for over 25 years. Quickly BERINGER® braking products have been appreciated by factory teams for their exceptional reliability, which has allowed BERINGER® to be present permanently in the World Championships.



These BERINGER brake and hydraulic clutch master cylinders, with a separated reservoir, have been specially designed for applications Supermotard, Enduro, Moto Cross and Sports.  
 They are very compact, very light and easy to fit under the handguards. The lever is easily adjustable and the adjustment of the idle stroke of the piston is accurately adjusted in the factory.  
 The Aerotec® range master cylinder, reduces friction by mounting axes with ball bearings. This technology provides more strength and a fine feeling along with a reduction of the effort together with an higher accuracy.  
 Thanks to this arrangement and radial technology, the braking power is increased by 40%.

The clutch control cable has the same design as the brake master cylinder, allowing to have symmetrical brake and clutch control, for a neat appearance.  
 The range of Aerotec® clutch control cable reduces friction by mounting axes with ball bearings.  
 The same technology to provide the same benefits in accuracy, strength and feeling.

**BERINGER® controls perfectly the quality to ensure full security for users of its brakes. Various quality certifications can attest: ISO 9001, UTAC, TÜV.**



The products are available in the 12 colors that BERINGER offers ... ask for your choice !  
 Black - Blue - Red - Gold - Silver - Purple - Green - Titanium - Chrome - Hard Nickel - Polish - Orange  
 Chrome option is available too !





# BERINGER BRAKES

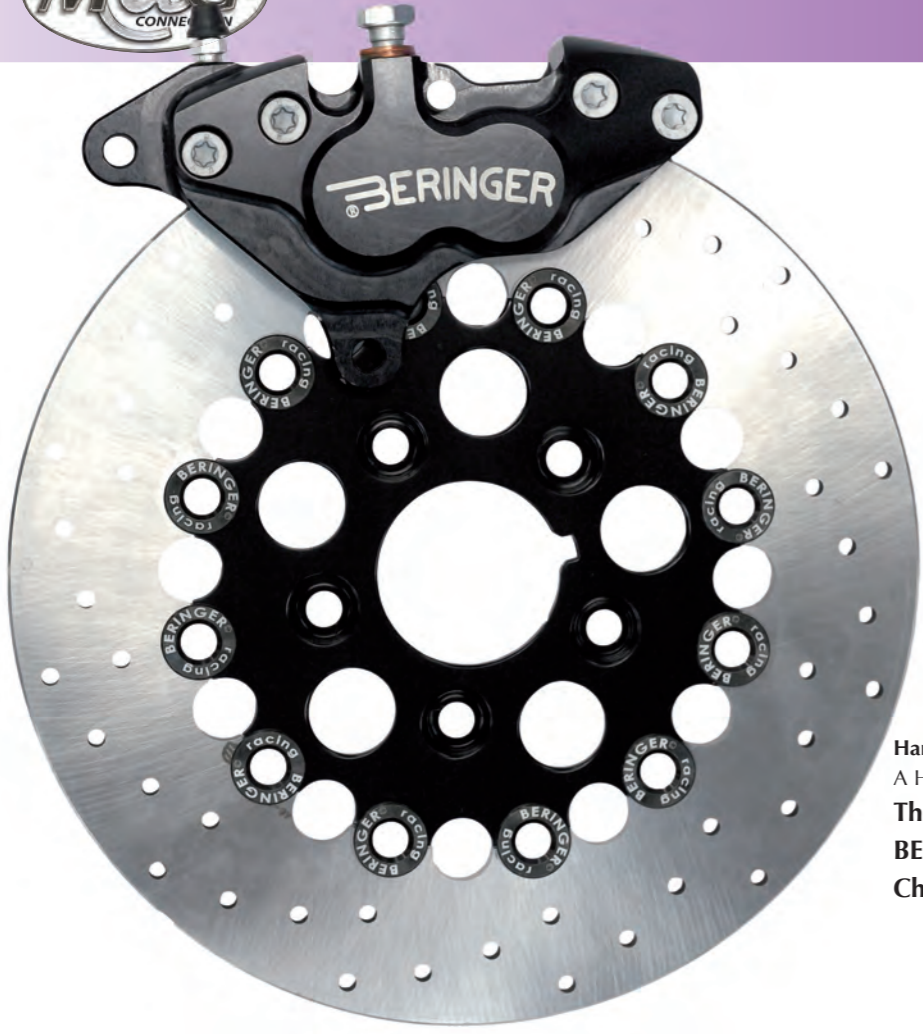

**Harley Range Discs**  
 A Harley range is also available with an aluminum hub in color  
**The discs are available in the 12 colors that BERINGER offers ... ask for your choice !**  
**Chrome option is available too !**



**4 Pistons Aerotec® Radial Calipers**  
**4 or 6 pistons Axial calipers**  
**Aerotec® 6 piston calipers range**  
 BERINGER calipers exist in several versions to meet any application. Cast in the iron in an aeronautic aluminium, they have been developed with the knowledge acquired from different competitions in which BERINGER is involved. Through innovative patents and innovative technical solutions, they have the advantage of responding quickly and thus provide outstanding braking feeling. The installation is done directly on the bracket.  
 BERINGER calipers are designed to mount directly on the fork, without any adaptive bracket. They are equipped with lower stop for pads, which allow an automatic and safe repositioning of the pads during their replacement.

**The products are available in the 12 colors that BERINGER offers ... ask for your choice !**  
**Black - Blue - Red - Gold - Silver - Purple - Green - Titanium - Chrome - Hard Nickel - Polish - Orange**  
**Chrome option is available too !**



**Aeronal® Disc**  
 BERINGER has developed, for several years, a range of upscale floating discs cast in the iron. These discs combine all the important points to ensure, at all times and all circumstances, an effective and constant braking. The use of narrow and smooth rotors, together with high performance aluminium alloy hub same as in aeronautics, achieves a 20% weight saving. The discs are designs for direct mounting on the wheel, instead of the original. Moreover, you can choose the rotor of your Aeronal® disc: stainless steel rotor for daily use, cast iron for sports use. Two types of hub are available: flat hubs and offset hubs.

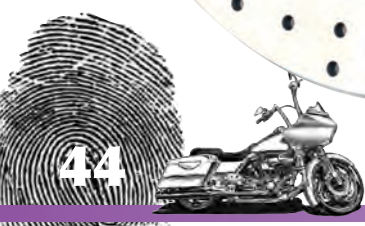
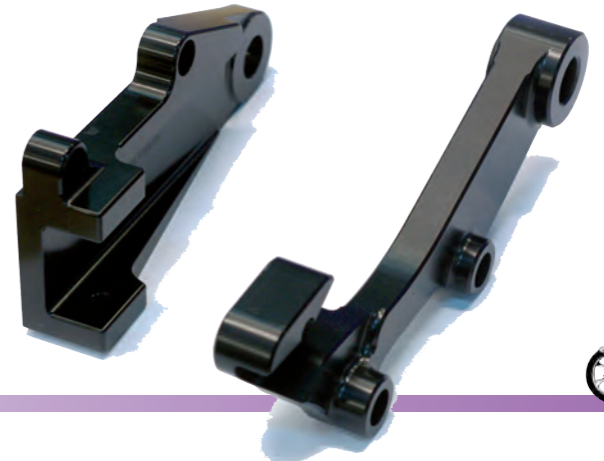



# BIKER'S CHOICE™



## BIKER'S CHOICE™



*Biker Choice is committed to earning our leadership position in the Powersport industry every day by providing value-added services with courtesy and integrity. Our desire to be your trusted and reliable source for after-market parts and apparel is second to none. With brands like : Vance & Hines, Progressive Suspensions, Performance Machine, Roland Sands Design, Bualy, Mustang, Memphis, Kuryakyn, National Cycle, you will get the better on the market in only one catalog !*





# BIKER CHOICE



# VANCE & HINES

All the products from Vance & Hines are in the Biker Choice Catalog including the news for the Softail's 2018. Exhausts complete sytem, slip ons, fuel controlers, air filters ... Just ask for your choice of product ... model and year of bike and finishes needed you will be delivered very fast with our huge stock



**High Output Short 2 in 1 System**  
The Hi-Output family expands the line with an aggressively stout 2-into-1. Engineered to be a compact version of our signature stepped megaphone, the Hi-Output 2-into-1 Short is perfect for the rider that demands the performance of a 2-into-1 and the distinctive sound of the Hi-Output. Available in Chrome or Black



**Eliminator 300 Slip Ons**  
expanded the popular Eliminator line to the Milwaukee-Eight powered Softail family. Crafted with precision-machined billet end caps inspired by the Vance & Hines flat track racer, Eliminator 300s are fine tuned with glass-wrapped acoustic baffles for a sumptuously resonant tone. Available in Chrome, Black or Wrinkle Black



**Shortshots Staggered**  
An unparalleled value, Shortshots Staggered deliver hot rod sound and performance wrapped in full length heat shields, at a price rivaling most slip-ons. Available in Chrome or Black



**Big Radius 2 in 2 System**  
The original game changer, Big Radius 2-into-2 brings together radical custom bike styling with precision quality features like full coverage heat shields and dyno-tuned baffles. Available in Chrome or Black



**HI Output Slip Ons**  
Give your Milwaukee-Eight Fat Bob the hot rod rumble to match its hot rod performance with HI-Output Slip-ons. Stepped, stacked and staggered, these blacked-out slip-ons are right on point for the radically styled Fat Bob. Available in Chrome, Black or Wrinkle Black



**Monster V Slip Ons**  
For distinguished touring riders, Monster V's are the premium slip-on mufflers of choice. The new Monster V's are the most refined design from Vance & Hines, meticulously executed from the smooth round inlet to the perfectly sculpted V shaped end cap. Monster V's produce deep mellow tones that will make you want to ride another hundred miles. Available in Chrome or Black



**Blackout 2 in 1 System**  
Without a doubt, two of the baddest looking models in the Harley Dark Custom line-up are the Sportster Iron and Nightster. Now Vance & Hines is putting out the baddest looking exhaust system to do these Dark Custom darlings justice, the Blackout 2-into-1. Compatible with all Sportster models 2004-13, the Blackout 2-into-1 makes the already quick and nimble Sportster a menace to be reckoned with.



**LCD Fuelpak**  
Your fuel injected American V-Twin is equipped with an ECU (electronic control unit) that's programmed to deliver fuel to the motor based on an air/fuel ratio for a stock air filter and stock exhaust system. While the ECU can self-adjust for environmental factors such as temperature and altitude, it can't adjust for mechanical changes like adding performance parts. When you install a performance exhaust system, your airflow changes, so you need a fuel management system that adjusts your air/fuel ratio to match the changes. That fuel management system is Fuelpak. The perfect combination with your performance exhaust system.



**VO2 Rogue Air Intake**  
Transform the look and feel of your bike with the VO2 Rogue Air Intake from Vance & Hines. The VO2 Rogue utilizes a high capacity deep pleated air filter featuring the K&N filter. Available in Chrome, Black or Wrinkle Black Finish



## PROGRESSIVE SUSPENSION

Founded in 1982, Progressive Suspension has evolved into the largest aftermarket motorcycle suspension manufacturer in the United States as well as a top tier supplier of suspension components to domestic OE customers. Our suspension systems can be found on premier customs, production trikes and just about any bike that's doing business.



Softail Series Chrome or Black



444 Series Chrome or Black



412 Series Chrome or Black



944 ULTRA TOURING 13" SHOCK, SITS AT 12"



944 ULTRA LOW 12.5" SHOCK, SITS AT 11"



Fork Lowering kits



Since 27 years, Our ideas are products of expressive minds that realize a motorcycle isn't simply a means of transportation, but rather a representation of a person's very identity. We are dedicated to producing innovative parts and accessories that keep us Miles Ahead.



Zombie Footpegs kit



Zombie Levers



Flame Design - Shiftpeg



Skull Horn Cover

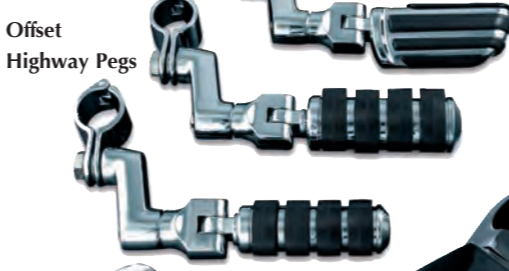

Offset Highway Pegs



Gauge Level



New Hypercharger design



Isogrip design



Horn Cover

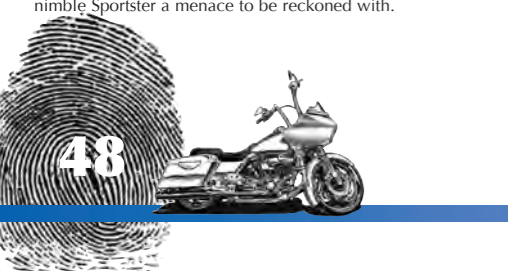



# BIKER CHOICE



Nearly two decades ago, two brothers, with motor oil in their blood and a lifetime commitment to custom, transformed simple bent tubing into chrome plated art and the Burly Brand was born.

Roland Sands Design is a motorcycle, product and apparel company that has its roots in racing, custom bike building and design. Our inspiration comes from a high performance background that blends the love of two wheels with the desire to create unique products. We live the two wheeled life and our crew is a diverse collection of road racers, off-road, dirt track, supermoto and custom bike builders and riders. It's this diversity that allows us to work with the best in the industry on a variety of projects. **You can get all his products ... just ask !**



All the handlebars from them and their famous cable kit are available

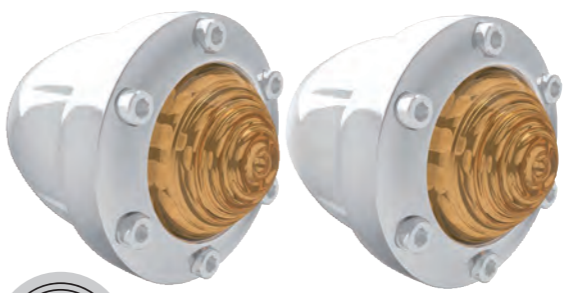

Proudly handcrafted in Three Rivers, Massachusetts, since 1980, Mustang Motorcycle Products, LLC continues to be the leader in the design and fabrication of world-class motorcycle seats. Every seat starts with a passion for riding and a deep-rooted belief in the tradition of quality American manufacturing. Skilled craftsmen form each seat by hand using the finest raw materials available for unrivaled comfort and longevity. Our engineering expertise is complemented by providing first-rate customer service – all under one roof in our historic New England facility.



Explore more about who we are, and the brands we offer. With over 4 decades experience doing what we do, we're pretty dang good at it by now. With the progressive level of engineering technology in our manufacturing, PM's focus in innovation is unmatched. And with our efforts to bring you the most well rounded portfolio of products from brand to brand, there's something for everyone.



All Wheels design From Performance Machine and RSD in all sizes for all bikes and all finishes available Assorted Pulleys and Discs also available !



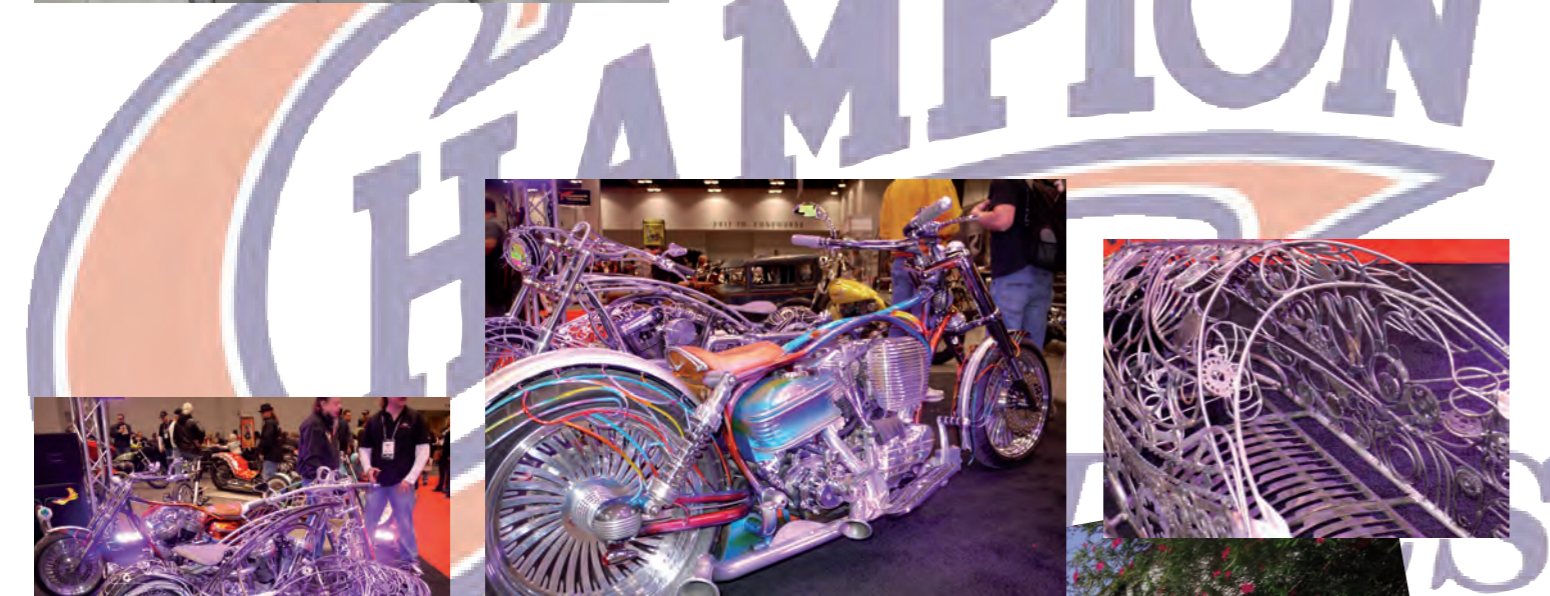

Champion has long been the leader in the trike and sidecar world.  
 We offer products for many of the most popular models on the road today.  
 We have an extensive dealer network to help keep your dream alive!  
 In addition to that, we also offer kits for the "do it yourself" builder.  
 We sell complete kits which are straightforward and very builder friendly,  
 you'll have everything you need to build your dream bike.  
 Add that to our easy to read installation instructions, and tech support,  
 building your ideal bike has never been easier.

*Made in America. Champion Trikes & Sidecars are 100% manufactured and assembled in the U.S.A*

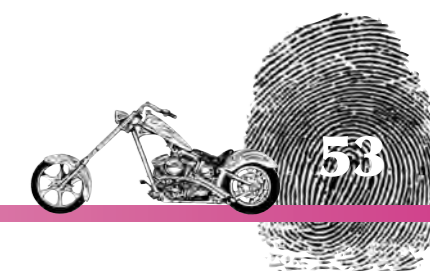
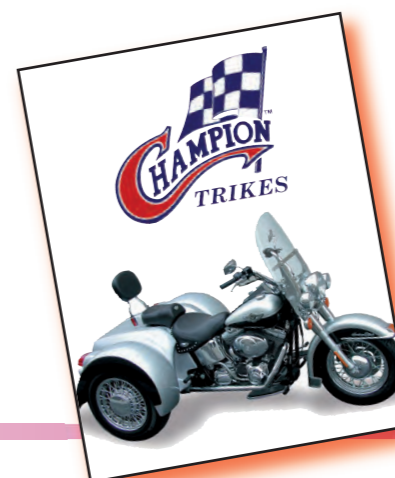



# CHAMPION TRIKE



## Reverse Gear

Champion is proud to offer the very best in mechanical reverse gears for your Harley Davidson motorcycle. Works on bikes, trikes, and sidecars, has Low Gear Ration for easy control and much more. Other companies may offer a reverse gear, but a Champion mechanical reverse gear has MANY advantages such as no battery drain and no electrical gremlins to track down.



### 5 Speed Reverse Gear



**5-Speed Applications**  
 Great for 2-wheelers, trikes or sidecars  
 Low gear ratio to ease you back  
 Does not affect any of the forward gears  
 Easy install, usually in about 4-5 hours  
 Overall transmission dimensions are unchanged  
 No exhaust modification needed for OEM applications.  
 (Please call for fitment on Softail Models.)  
 Made with precision-engineered aerospace materials  
 Easy-to-follow instructions  
 Clutch operated, no battery drain  
**CT/AREV001**

### 6 Speed Reverse Gear - FLH Touring 07-08 Cable Clutch



**Clutch Cable Operation**  
 Great for 2-wheelers, trikes or sidecars  
 Low gear ratio to ease you back  
 Does not affect any of the forward gears  
 Easy installation in about 4-5 hours  
 Overall transmission dimensions unchanged  
 No exhaust modification needed for OEM applications.  
 (Please call for fitment on Softail Models)  
 Aerospace Materials, precision-engineered  
 Easy-to-follow instructions  
 Clutch operated, no battery drain  
**CT/ARG101001**

### 6 Speed Reverse Gear - FLH Touring 09 Up Cable Clutch



**For Cable Clutch Operation**  
 Great for 2-wheelers, trikes or sidecars  
 Low gear ratio to ease you back  
 Does not affect any of the forward gears  
 Easy installation in about 4-5 hours  
 Overall transmission dimensions unchanged  
 No exhaust modification needed for OEM applications  
 (Please call for fitment on Softail Models)  
 Aerospace Materials, precision-engineered  
 Easy-to-follow instructions  
 Clutch operated, no battery drain  
**CT/ARG101011**

### 6 Speed Reverse Gear - FLH Touring 09 Up Hydraulic Clutch



**Hydraulic Clutch Operation**  
 Great for 2-wheelers, trikes or sidecars  
 Low gear ratio to ease you back  
 Does not affect any of the forward gears  
 Easy installation in about 4-5 hours  
 Overall transmission dimensions unchanged  
 No exhaust modification needed for OEM applications  
 (Call for fitment on Softail models)  
 Aerospace Materials, precision-engineered  
 Easy-to-follow instructions  
 Clutch operated, no battery drain  
**CT/ARG101012**

### 6 Speed Reverse Gear - FLH Touring 07-08 Hydraulic Clutch

**Hydraulic Clutch Operation**  
 Great for 2-wheelers, trikes or sidecars  
 Low gear ratio to ease you back  
 Does not affect any of the forward gears  
 Easy installation in about 4-5 hours  
 Overall transmission dimensions unchanged  
 No exhaust modification needed for OEM applications  
 (Please call for fitment on Softail Models)  
 Aerospace Materials, precision-engineered  
 Easy-to-follow instructions  
 Clutch operated, no battery drain  
**CT/ARG101002**

### Mechanical Reverse Gear Kit for Victory Crossfire

Do you want the convenience of being able to back up your trike with ease? That's no problem with the purchase of an electric reverse gear for your Cross-country or Cross-Roads trike. It makes backing up a breeze.



CT/AREV004







# CHAMPION TRIKE



## Trikes Kit

Champion has long been the leader in the triking industry. With trike conversions for some of the most popular motorcycle models on the road, it is easy to see why Champion is the leader in the trike conversion world.

So, you didn't think a full-on Dresser said exactly the right things about how you experience life, and you decided to lay your hard-earned cash down on a Harley-Davidson® Softail? Good choice, because Champion has a trike kit for you! Regardless of whether your bike is a full-custom or factory original, that Harley attitude is always present in your Champion trike. With engineering advantages in the swing arm and suspension technology, a custom-designed drive train and a high-performance disc brake system, we're confident that our Softail trike will have no problem proving to your friends, or to the highway, that the owner of this trike still breathes Harley!



## Softail Trike Kit



### Standard Features

- Gel-Coat (included in Base Price)
- High-performance, independent front and rear disc brake systems - Increased safety when braking in turns
- Champion-designed "Easy-Install" rear-end - A custom-made differential, designed to fit the OEM's drive sprocket.
- Powder-coated structural components - Improved durability, longer lasting coating system
- Reinforced fiberglass body construction - Rugged, durable product that will last longer
- Extra-large trunk plus over-wheel storage - Increased capacity: two full-face helmets and more
- OEM tail and signal lights - Preserves classic Softail styling
- Drive belt included with '87-'99 FLSTC models only.

### Technical Specifications

- Overall Width: 55.5"
- Overall Length 97.25"
- Overall Length (w/ EZ Steer): 99.75"
- Wheelbase: 63"
- Wheelbase w/ EZ Steer: 66.5"
- Load Capacity: 600lbs
- Tire Size: 205/70R-15
- Storage Capacity: 5.75 Cubic Feet
- Brakes: High Performance Dual Discs
- Electrical: Plug & Play Connectors
- Solid Axle Suspension: A "Zero-flex" swing arm using OEM shock with 2 additional progressive, adjustable coil over "helper" shocks
- Independent Suspension: A double A-Arm Independent suspension with high pressure gas shocks



## Touring Trike Kit

The all new Champion FLH trike kit features our Comfort Ride Trike (CRT) suspension. The new Independent Suspension features high pressure gas shocks, forged upper and lower control arms and high pressure cast components for added strength and reliability while reducing weight. The standard sway bar can be upgraded to our patent pending Variable Sway Control (VSC) system allowing for increased performance in handling and comfort on the highway. Our FLH trike kit is built to the highest standards by craftsmen dedicated to producing a product that will out-perform, out-ride and out-shine all competitors. With performance features like disc brakes, our "Zero-Flex" swing arm, and our custom-designed mounting hardware, which features the fastest and cleanest installation available of any trike company. This beauty is certain to keep your dreams alive!



## Sportster Trike Kit

Champion is proud to offer its very best in the way of a light-weight trike. The Harley-Davidson Sportster is one of the most popular bikes on the road, so it only made sense to trike out an American classic. With everything needed to turn your Sporty into a trike, it is an easy choice to see why Champion remains on top.

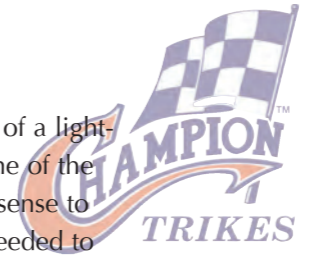

## Full Body Sportster Raider

The latest addition to the Champion lineup is the Sportster Raider. This full body trike offers the light-weight performance our customers have grown to love about our Sportster trikes, while adding a full bodied trunk with a handsome amount of storage capacity. You'll get both performance, AND style, at a fantastic price.



## Open Body Sportster Trike Kit

**Standard Features**  
High-performance, independent front and rear disc brake systems  
- Increased safety when braking in turns  
Champion-designed "Easy-Install" rear-end  
Powder-coated structural components - Improved durability, longer lasting coating system  
OEM tail and signal lights - Preserves Classic Sportster styling



## Open Body and Full Body Dyna Trike Kit Available



### Standard Features

- Gel-Coat (included in Base Price)
- High-performance, independent front & rear disc brake system increases safety when braking in turns
- Champion's "Easy-Install" rear-end with a custom differential designed to fit the OEM's drive sprocket.
- Powder-coated structural components, which improve durability, with a longer lasting coating system
- Reinforced fiberglass body construction - Rugged & durable material ensures the product that will last longer
- Extra-large trunk, plus over-wheel storage - Increased capacity fits two full-face helmets and more!
- OEM tail and signal lights, which preserves the classic FLH styling features

## Touring Trike Kit





# Corbin®



# Co



Corbin's factory is located in the historic town of Hollister in Central California. The small California town of Hollister is deeply rooted in motorcycle history and is considered the Birthplace of the American Biker image.

Our East Coast Showroom and Warehouse is open seven days a week and is a popular stop during Bike Week & Biketoberfest.

It started with a Norton Atlas. Now the Corbin name is synonymous with Quality, Hand Crafted motorcycle saddles worldwide.

Hand build with pride in the USA using proprietary, purpose built materials and patented manufacturing processes.

With more seat applications across more brands and models than any other motorcycle seat maker.

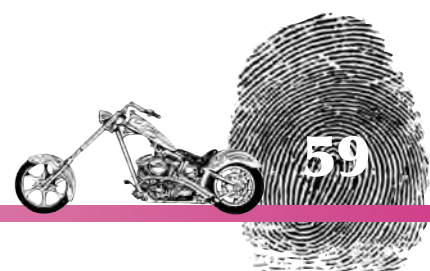

Most of our seats are available for your bike model and year !

You have the choice of material for : the seating panels, side panels, welts, stud bands and stud or no !

And all these options are with no extra charge !

### Dual Touring Saddle

Incredible comfort gains that look great. Corbin has a long history of designing saddles that look as good as they perform and this Dual Tour is no exception. Notice how well the saddle fits to the tank and fender and provides two large seating buckets that don't overpower the bike visually. We sculpt each seating area for proper weight distribution and allow long range capability. Generously contoured platforms eliminate hot spots and centralized pressure that causes discomfort. On the inside, our exclusive Comfort Cell® foam material gives firm support that conforms to your body. And as an added bit of luxury, we offer the option of electric seat heaters for those chilly morning rides. Dual Touring Saddle accepts two optional removable backrests for added back support and also works with a Harley-Davidson sissybar (not all models). Our backrests are fully adjustable to provide a tailored fit to individual's posture.



### Hollywood solo Saddle

Hollywood Solo saddle gives your bike a slick profile while providing you with boulevard cruising comfort. Our Fibertech basepan designed specifically for the Bagger chassis provides a perfect, flowing fit along the tank and hugging the chassis with a perfect fit and no gaps. The whole seat rides on rubber bumpers to protect your paint job. Built up with high density Comfort Cell® foam to provide a firm resilient ride despite the low profile. It's seats like this one that that make Corbin seats second to none in comfort and style. Hollywood Solo comes standard with genuine leather seating for a truly luxurious ride. We offer a range of unique colors and materials to choose from and multiple intricate stitch patterns in a variety of thread colors.



### Gunfighter Saddle

The world famous Gunfighter design combines rider comfort and a fast look available in two variations for rider's of different stature. Up front an ergonomically contoured saddle provides a large area of body contact for best weight dispersion. Features a fastback tail section that is padded and upholstered to provide for short trip passengers while providing the rider with lower back support. Our "Close" version has a seating area built closer to the bars with a narrower nose to give better ground reach. Both Models of the Gunfighter design accept our removable rider's backrest in a variety of styles. The special hardware in this setup allows for multiple adjustments to tailor it's fit perfectly to your posture. You can adjust the position before & after while also changing the backrest angle. It's even spring loaded so it will fold down to make it easier to mount your bike. Our backrests install easily into hardware concealed in the saddle so there are no unsightly brackets to clutter up the look of your bike. We offer a variety of backrest styles to suit your taste and the amount of support you wish.



### Classic Solo Saddle

Classic solo is designed to provide maximum rider comfort combined with a classy, nostalgic look. Provides the use of our removable rider's backrest for 14 inches of vertical back support. Our sculpted seating position gives maximized body contact and provides true touring comfort. Neutralized seat platform offers an easier reach to the ground and a more ergonomic position on the bike. Corbin's Classic Solo saddle is also available in a CLOSE version that provides seating closer to the bars and a narrower nose for easier ground reach.



### Fleetliner Trunkbox for HD Motorcycles

The new, larger touring capacity trunk! Corbin's Fleetliner trunk provides 71 liters of storage with a shape designed to facilitate TWO full face helmets.

The organic lines of the Fleetliner trunk do a great job of visually disguising the massive storage it provides. Triple chrome strips give a nice accent and further minimize the appearance on the bike. The Corbin wizards created a shape that integrates well with the bike's smooth, flowing lines. This shape more aerodynamically efficient too so the trunk slips through the wind easier.

Inside, the Fleetliner trunk offers plenty of room for a weekend trip.

Manufactured of our durable Fibertech material, Fleetliner trunk comes complete and ready to install on your existing H-D rack. Weather stripping, liner, hinges and door lock hardware come preinstalled. Available in primer gel coat ready for your painter's preparation or pre-painted gloss black for a little extra.



### Streamliner Trunkbox for HD Motorcycles

Large enough for a weekend getaway yet smooth enough to look cool. The organic lines of the Corbin trunkbox do a great job of visually disguising the massive 55 liters of storage it provides. On the front a generously sculpted trunk pad provides excellent support for your copilot too. Makes you wonder why nobody's made a trunk like this before doesn't it?

Inside, the Streamliner trunkbox offers plenty of room for a weekend trip. Fully lined on the inside to protect your contents during travel. Rubber weather stripping keeps contents dry should you get caught in nasty weather. Of course the door locks for security and opens up and forward so it will self close if forgotten.



### SissyBar Pads

Corbin makes a variety of backrests for your co-pilot's touring pleasure. Each model comes coordinated to your saddle design for a totally integrated look. Naturally, these models are in addition to the original Corbin integrated backrest that many of our saddles accept.



### Barstool

Finally a classic Corbin saddle for the home! Perfect for your man cave, kitchen counter or even place of business.

Available in two heights so they're suitable for standard desks and tables or a taller model for counters and bars. Short model is approximately 21 inches to seating surface while tall model is 27 inches. Both models include chromed steel legs, plastic leg caps and 360 degree swivels so the seating rotates. These ship flat so some minor assembly is required.

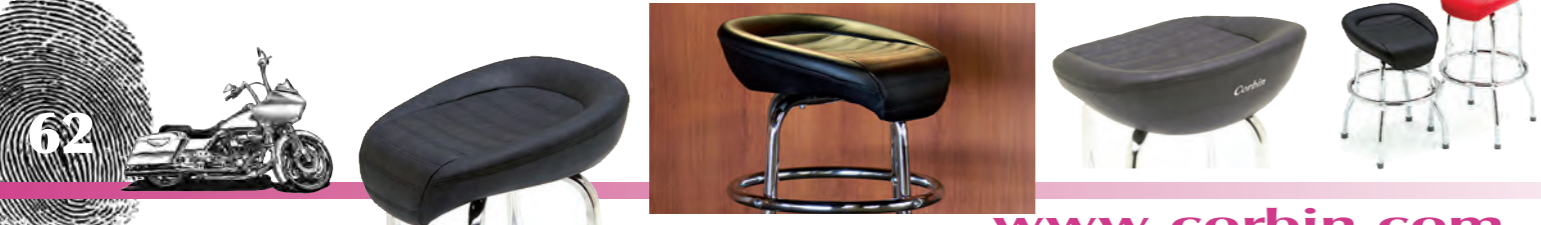

### Styling components for Harley FXR

A lot has happened in the motorcycle industry in the last two decades: Big Tire Choppers... Classic Bobbers... return of the Cafe Racer... Stretched Baggers... But it seems the Warbird style was never forgotten. This year Mike finally caved in to the myriad of requests and has redesigned the Warbird style for a new release!

The Warbird is a series of components designed to work together for a unified look or can be used individually to convert a stock Harley-Davidson FXR into a rolling work of art. Together the components capture the essence of classic Warbirds like the Corsair, Mustang and Thunderbolts for an aggressive stance and smooth aerodynamic line. The system is comprised of:

- Warbird Fairing for FXR
- Corbin Chin Spoiler
- Smooth Side Covers
- Warbird Tail section
- Warbird Custom Saddle



Corbin

Corbin



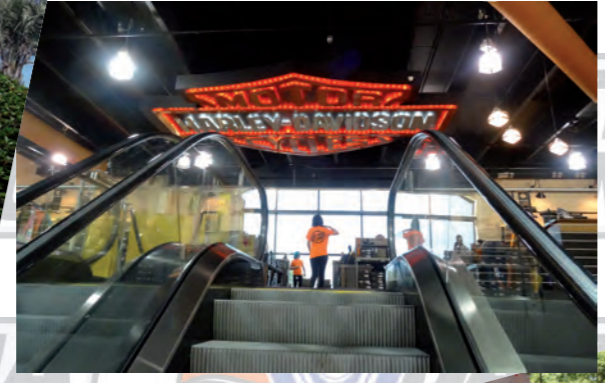

Daytona Twin Tec has a simple philosophy – do one thing and do it well. Our product focus is electronic fuel injection and ignition systems for Harley-Davidson and is based on the most advanced technologies. Our products are manufactured locally in a highly automated Iso 9000 facility. Our Chief Operating Officer, Allen Alvarez, was recently given a Lifetime Achievement Award by Easy Riders Magazine in recognition of his almost 40 years involvement with the motorcycle industry. Allen started his career in the motorcycle industry in 1970 officiating motorcycle road races. In 2001 he decided that it was time to start his own company, Daytona Twin Tec.





## Fuel Injection

A complete line of fuel injection products. From a stage 1 upgrade to Turbo or ProCharger, we've got you covered.



Call for application

### Twin Tuner Fuel Injection Controllers for 2001-2017 Harley-Davidson® Twin-Cam and 2007-2014 Sportster® with Delphi® System and 2003-2010 Buell® with DDFI Fuel Injection

- Increases horsepower
- Improves throttle response
- Easy plug-in installation and setup
- Very compact size - only 4"L x 2"W x 1/2"H
- Compatible with Twin Scan II Plus Tuning Aid
- Low cost



- DAY/16200 ... 2001-2011 Twin cam 2007-2013 Sporty
- DAY/16201 ... 2012-2017 Can Bus except Touring
- DAY/16202 ... 2008-13 Tournig models
- DAY/16203 ... 2002-2017 V-Rod

### Twin Tuner II Fuel Injection and Ignition Controllers for 2001-2013 Harley-Davidson® Twin-Cam with Delphi® System, 2007-2013 Sportster® and 2002-2017 V-Rod™

- Increases horsepower
- Improves throttle response
- Eliminates spark knock
- Easy plug-in installation and setup
- Very compact size - only 4"L x 2"W x 1/2"H
- Compatible with Twin Scan II Plus Tuning Aid
- Low cost



- DAY/17400 ... 2001-2011 Twin cam exc 2011 Softail Dyna
- DAY/17400EX ... 2001-2006 88ci Twin cam
- DAY/17401 ... 2007-13 Sporty
- DAY/17402 ... 2001-2011 Twin Cam with Turbo

### TCFI Gen 4 Fuel Injection Controller for 2001-2013 Harley-Davidson® with 36 Pin Delphi® System

- Fully programmable plug-in replacement for 36 pin Delphi® controller with J1850 data bus. Not compatible with 2008 and later touring models with electronic throttle control. Not compatible with 2011 and later models with CAN data bus
- Quickly auto-tune fuel curves for front and rear cylinders on a dyno or on-road with new WEGO IIIID dual channel wide-band oxygen sensor interface
- Robust alpha-N (throttle position and RPM based) fuel control eliminates problems with long duration/high overlap camshafts
- Extended data logging and diagnostics. DataFLASH memory stores full 60 minutes of operating data at 10 samples/second.
- Powerful Windows software for custom programming and data analysis
- Programmable user input for functions such as two stage RPM limiter, nitrous retard, and shift kill (not available in TCFI EX version)
- Programmable user output for functions such as shift light, nitrous activation, and electric shifter (not available in TCFI EX version)
- Billet aluminum housing with black anodized finish
- Easy plug-in installation

### TCFI Gen 5 Fuel Injection Controller for CAN Bus Models Including 2012-2017 Dyna® and Softail® and all 2014 and later Except Touring

- Fully programmable plug-in replacement for the 36 pin controller with CAN data bus used on 2012 and later except touring models. Not compatible with 2011 Softail® that uses a different size controller.
- Quickly auto-tune fuel curves for front and rear cylinders on a dyno or on-road with new WEGO IIIID dual channel wide-band oxygen sensor interface
- Robust alpha-N (throttle position and RPM based) fuel control eliminates problems with long duration/high overlap camshafts
- Extended data logging and diagnostics. DataFLASH memory stores full 60 minutes of operating data at 10 samples/second
- Powerful Windows software for custom programming and data analysis
- Programmable user input for functions such as two stage RPM limiter, nitrous retard, and shift kill
- Programmable user output for functions such as shift light, nitrous activation, and electric shifter
- Billet aluminum housing with black anodized finish
- Easy plug-in installation



- DAY/17600 ... Can Bus models
- DAY/17601 ... 2014-17 Sporty



DAY/17700 ... 2008-13 Tournig

### TCFI Gen 6 Fuel Injection Controller for 2008-2013 Harley-Davidson® Touring Models with Electronic Throttle Control

- Fully programmable plug-in replacement for 73 pin Delphi® controller with J1850 data bus used on 2008-2013 touring models with electronic throttle control.
- Quickly auto-tune fuel curves for front and rear cylinders on a dyno or on-road with new WEGO IIIID dual channel wide-band oxygen sensor interface
- Robust alpha-N (throttle position and RPM based) fuel control eliminates problems with long duration/high overlap camshafts
- Support for gear indication on accessory speedometers
- Powerful Windows software for custom programming and data analysis
- Extended data logging and diagnostics. DataFLASH memory stores full 60 minutes of operating data at 10 samples/second.
- Programmable user input for functions such as two stage RPM limiter, nitrous retard, and shift kill input and output
- Programmable user output for functions such as shift light, nitrous activation, and electric shifter
- Billet aluminum housing with black anodized finish
- Easy plug-in installation



DAY/17800 ... 2014-16 Tournig

### TCFI Gen 7 Fuel Injection Controller for 2014-2016 Harley-Davidson® Touring Models with Electronic Throttle Control. Twin Cooled® Models now supported!

- Fully programmable plug-in replacement for 54 pin Delphi® controller with CAN data bus used on 2014-2016 touring models with electronic throttle control, TwinCooled® Models now fully supported.
- Quickly auto-tune fuel curves for front and rear cylinders on a dyno or on-road with new WEGO IIIID dual channel wide-band oxygen sensor interface
- Robust alpha-N (throttle position and RPM based) fuel control eliminates problems with long duration/high overlap camshafts
- Extended data logging and diagnostics. DataFLASH memory stores full 60 minutes of operating data at 10 samples/second.
- Powerful Windows software for custom programming and data analysis
- Programmable user input for functions such as two stage RPM limiter, nitrous retard, and shift kill and output
- Programmable user output for functions such as shift light, nitrous activation, and electric shifter
- Billet aluminum housing with black anodized finish
- Easy plug-in installation

### TCFI Gen 8 Fuel Injection Controller for 2017+ Harley-Davidson® Milwaukee Eight® Models.

### VRFI Gen 4 Fuel Injection Controller for 2002-2017 V-Rod™

- Fully programmable plug-in replacement for 36 pin Delphi® controller with J1850 data bus.
- Quickly auto-tune fuel curves for front and rear cylinders on a dyno or on-road with new WEGO IIIID dual channel wide-band oxygen sensor interface
- Robust alpha-N (throttle position and RPM based) fuel control eliminates problems with long duration/high overlap camshafts
- Extended data logging and diagnostics. DataFLASH memory stores full 60 minutes of operating data at 10 samples/second.
- Powerful Windows software for custom programming and data analysis
- Programmable user input for functions such as two stage RPM limiter, nitrous retard, and shift kill
- Programmable user output for functions such as shift light, nitrous activation, and electric shifter
- Billet aluminum housing with black anodized finish
- Easy plug-in installation





# DAYTONA TWIN TEC



## Carbureted Ignitions

Whether you have a 1970 Shovel or you're building a custom Twin Cam, you're sure to find a system that will spark your interest.

### Model 1005 Internal (Nose Cone) Ignition with Versions for 1970-1999 Big-Twin®, 1971-2003 Sportster®,

- Wide timing advance adjustment range accommodates stock to highly modified engines
- Digitally set RPM limit (100 RPM steps)
- Selectable single or dual fire mode
- Selectable multi-spark mode for quick starting and smooth cruise
- Coil outputs protected against short circuits
- Optional USB interface and software for programming a custom advance curve
- Billet aluminum housing

### VT-i Electronic Ignition for Harley-Davidson® V-Twin Engines Except Early Magneto Type and 1999 and Later Twin-Cam®

- Ultra reliable dual fire electronic ignition system for all Harley-Davidson® V-twin engines except early magneto type and 1999 and later Twin-Cam®
- Includes special trigger rotor for use with traditional mechanical advance mechanism (supplied by customer)
- Precise digitally set RPM limiter (200 RPM steps from 5,200 to 7,000 RPM)
- Status LED for easy static timing
- Electronic dwell control for maximum ignition energy at high RPM and reduced current draw at low RPM
- Compatible with most original equipment and aftermarket dual fire ignition coils (3-5 ohms primary resistance)
- Easy installation. Simple two wire hookup to coil
- Hall effect sensor detects teeth on special trigger rotor and provides very stable spark timing
- Operates down to below 6 volts for reliable starting under all conditions, including kick start
- Fully encapsulated construction using surface mount electronics. Waterproof and highly resistant to vibration and shock
- Over-temperature protection. Rated to operate at 125° C (260° F)

### Models 1006 and 1007 External Plug-In Ignition Modules for 1990 and Later Evolution® Big-Twin® and 1990-1993 Sportster®

- Wide timing advance adjustment range accommodates stock to highly modified engines
- Digitally set RPM limit (100 RPM steps)
- Selectable single or dual fire mode
- Selectable multi-spark mode for quick starting and smooth cruise
- Coil outputs protected against short circuits
- Optional USB interface and software for programming custom advance curve
- Billet aluminum housing with black anodized finish
- Easy plug-in installation

### TC88 Plug-In Ignition Module for 1999-2003 Carbureted Twin-Cam 88® Engines

- Wide timing advance adjustment range accommodates stock to highly modified engines
- Digitally set RPM limit (100 RPM steps)
- Selectable multi-spark mode for quick starting and smooth cruise
- Coil outputs protected against short circuits
- Optional USB interface and software for programming custom advance curve
- Billet aluminum housing with black anodized finish
- Easy plug-in installation
- Supports all sensors including theft/security module

### TC88 Plug-In Ignition Module for 1999-2003 Carbureted Twin-Cam 88® Engines

- Wide timing advance adjustment range accommodates stock to highly modified engines
- Digitally set RPM limit (100 RPM steps from 3,000 to 9,900 RPM)
- Full support for J1850 data bus used for communications with instrument cluster and turn signal/security module (TSM/TSSM)
- Compatible with aftermarket tachometers
- Built-in data logging. Stores last 30 minutes of engine operation
- Extensive diagnostics
- Optional USB interface and software for custom programming and data analysis.
- Billet aluminum housing with black anodized finish
- Easy plug-in installation



**3 Ohm Mini Coil Kit**  
 (compatible with most aftermarket single fire ignitions. Includes two coils, universal spark plug wire set and parts bag with terminals.)  
**DAY/2006KIT**



**3 Ohm Mini Coil**  
 (compatible with most aftermarket single fire ignitions.)  
**DAY/2006**



**High Output Coil**  
 (for most 1999 and later carbureted Twin-Cam 88® applications)  
**DAY/2008**



**High Output Single Fire Coil**  
 (3 ohm primary compatible with all Twin Tec and most aftermarket single fire ignitions.)  
**DAY/2005**



**Universal Spark Plug Wire Set**  
 (8.5mm black silicone with 500 ohm/ft spiral core. For all applications except Twin-Cam 88®. Includes both 90° and 115° spark plug boots and assorted coil boots and terminals.)  
**DAY/3003**



Crimp Tool



**Twin Scan Complete Kit**  
 · Includes both Twin Scan II ABS (for 2001-2014 models with J1850 data bus), Twin Scan 3 ABS (for 2011+ models with CAN data bus, 6-pos DLC connector), WEGO IIID for tuning capability with both Twin Scan versions, and the Twin Scan 3 Probe Kit for use with the scopemeter feature of the Twin Scan 3 ABS.



**DAY/154001**  
 (includes both Twin Scan II ABS and Twin Scan 3 ABS units, WEGO IIID Interface, two Bosch LSU 4.2 wide-band oxygen sensors, two 18 x 1.5 mm weld nuts, two 18 x 1.5 mm hex socket plugs, USB cable, probe kit, and software on CDROM)



Call for application



**DAY/1006EX** ... 1990-94 1340 Evo 90-93 883 XLH  
**DAY/1007EX** ... for 1994-99 1340 Evo



**DAY/1008EX** ... 99-2003 carbureted Twin-Cam 88  
**DAY/1008** ... Race Plug-in for TC 88 carbureted  
**DAY/1008T** ... 99-2003 carbureted TC88 Drag Racing



**DAY/1009EX** ... for 2004-2006 carbureted TC 88  
**DAY/1009** ... for 2003-2006 carbureted TC 88 and Sportster® with new 12 pin

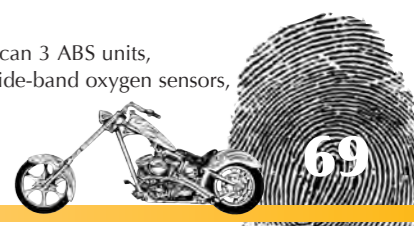

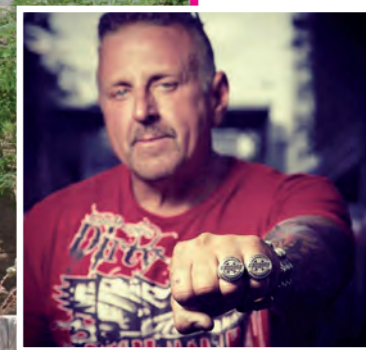
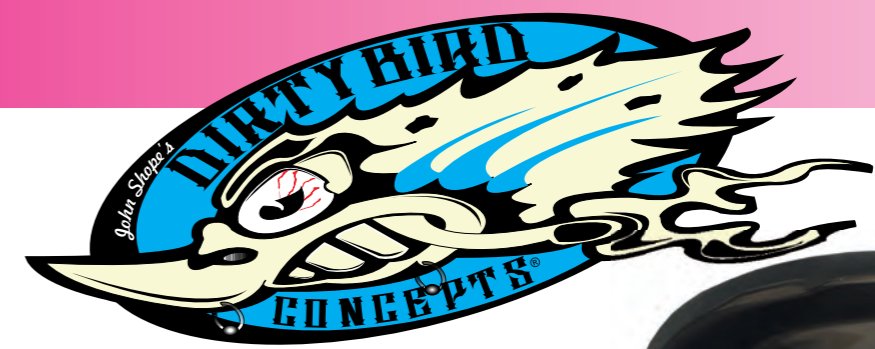

John Shope started in the 80s as an artist and sculptor prior to entering the custom bike business. It wasn't until the big economy crash that John knew he had to make a move in the motorcycle industry. He purchased a new bike and began not only creating new parts but, cutting up the stock ones. He wasn't quite sure how the motorcycle community would respond but, he knew he was onto something and kept pushing forward. Known as, *The Risk Taker*, John continues to take chances in this industry striving to find the next great thing.

Over the years John has won several awards including *Chopped Bagger Best of Show*, *Buffalo Chip Supreme Sturgis Showdown* (as seen on *Biker Battleground*) and won the title of *Grand Champion Winner* in the *Baggers Invitational Bike Build-Off* 2014, 2015 and 2016. To top it all off, in 2015 John received the greatest honor of all; he was inducted into the *Sturgis Motorcycle Museum and Hall of Fame*.

In John's mind, creating and designing new parts goes way beyond success. It's giving fellow riders the ability to become creative in a wide range of budgets and maybe even a bragging right here and there. Aside from providing new ideas and excellent parts, John's main goal is to be a loving husband to his wife, Sara, and an excellent father to his three boys. After all, they are the true meaning behind his success.

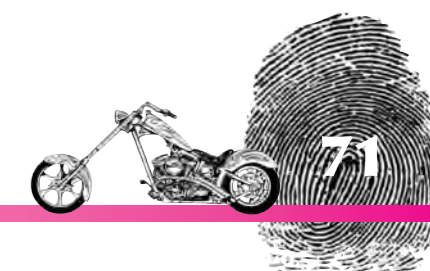



Dirty Bird Concepts designs high performance custom after market bagger parts for Harley Davidson and Indian motorcycles. From the Harley and Indian baggers to the latest Softail, Fatboy and Dyna creations, John Shope is constantly changing the game with his innovative designs.



**Dirty Money Road Glide Cover**

The new Dirty Money Cover and Cap gets rid of the factory HD gauges and cleans up the bike for a real custom look. Made from our famous NYB polymer blends so you know this guy is tough as shit with superior fitment.



**Road King or Softail Streamline Dash**

John Shope brings you this Streamline Road King dash and also available for your Softail including Fat Boy that replaces your stock factory Harley Davidson dash, because lets be honest stock shit for losers. It is paintable and adds a sick design that will set your bagger or Softail apart from the rest.



**Stealth Seat**

John Shope's fully one of a kind custom seat will only fit with your 2009 to present Road Glides, Electra Glide and Street Glide baggers with our Cutting Edge Tank Kit. This complete seat will not work for the Road King Cutting Edge Tank Kit or our Long Shot Tank Kit. Made from an injected pan with dense padding and durable stitching. This complete seat is made specifically to fit with our tank kit. If you want to do your own seat check out our seat pans.

**Rear Fenders**

A large choice of rear fender to fit your bike and year. Made from hand laid fiberglass so you know its super stiff, strong and straight. These fenders were designed to be used with a lowering kit so the lines of the fender flow with the bike.



**Windshields**

John's slick design sets your Street Glide or Electra Glide bike apart from the boring factory windshields. The top has a flip for a cool style and wind coverage. They are great for big wheel bikes and allow you to see over the fairing. The dark smoke transparent tint windshield makes it easy to see through.



**Harley Davidson Motorcycle Chin Spoiler**

New chin spoiler for the 2017 to present touring models. This new spoiler will give you some added much needed style paint and performance by forcing air into the motor channeling. This spoiler works with or without crash bars, stock or raked bikes and comes with all the mounting hardware needed.



**Handlebars**

Get that relax comfortable ride out of your bagger with our DBC bars. TIG pre-drilled to run internal wiring to make it easy and they can also be used for new Harley Davidson's fly by wire. Look great on Fat boys, Heritages, or any other custom bike. For a clean fitment, use a round file on the fly by wire side to deburr the edges.



**Grips for Harley**

These grips are state of the art. John's new Gnarly Super Grip design for your handlebars will keep your hands from going numb on those long ride with our new rubber inserts inside the grip. These rubbers are nice and soft but will not wear out fast and will not get all rotten out by the elements.



**HotRod for Road Glide Bars**



**Down & Dirty Road Glide Bars**



**Indians Head Up Bars  
4" or 8"**





# DIRTY BIRD CONCEPT



**Harley Road Glide Headlight Bezel**  
gives your stock Road Glide the aggressive pissed off custom look in minutes. All stock components function as normal and there are no obstructions to the headlight and air vents function as normal. Give your ride a move it scum bag or lose it stare.



**Indian – The Louver Scout Chin Spoiler 2014 To 2018**  
John Shope brings you a new slick design for your Indian Scout, Scout 60 and Bobber. The Race Tech Series chin spoiler helps force air into the radiator for a functional yet stylish body part. Made from our famous NYB injection mold polymer, so you know its a tough bitch with superior fit and finish. Bolts right in with no modifications needed. Does not restrict air, it channels air into the radiator for better cooling efficacy along with a guard mesh that protects your radiator from debris. The Mesh screen comes in your choice of black or chrome.



**Harley Front Fender The Race Line 26"**  
Crazy and new from John Shope to bring you the sickest Softail parts line or for your touring Road Glide, Street Glide, Electra Glide and Road King. Only the best 14 gauge steel hand spun Harley front fenders designed to hug the tire and flow with the rim to give you that slick design.



**Indian Scout Motorcycle Seat**  
John Shope and Mustang have teamed up together to design and manufacture this amazing product for the Scout and Scout 60. This Café seat features double stitched, high quality expanded vinyl and a perforated-design tuck and roll stitched center panel for a custom flair

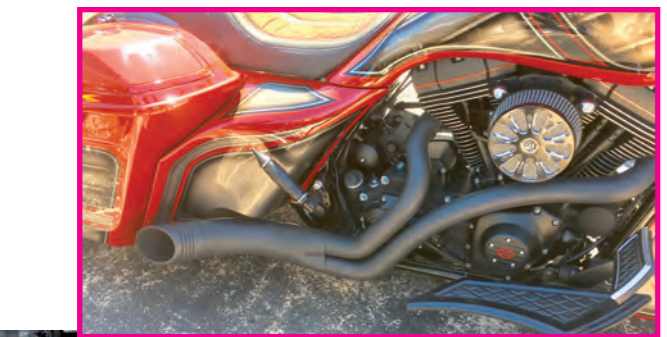

**Harley – Up Yours Performance Exhaust 2000 To 2018**  
The Up Yours Harley Performance Exhaust was designed John to increase horsepower and has a high performance baffle for back pressure perfect for your big V-Twin or Milwaukee 8. Hits 76.59 HP and 88.23 torque with our air cleaner on your touring model bikes.



**Indian – Race Tech Series Scout Performance Exhaust 2014 To 2018**  
John Shope brings more power and more sound to the Indian Scout exhaust system, as well as Scout 60 and Bobber. Gets rid of the huge stock OEM factory system and loses 20 pounds hanging off one side of the bike, reducing weight and improving balance. Designed to hug the bike and lose weight while adding more power the race way.



**Harley – BMF Performance Exhaust 2000 To 2018**  
Check out this Bad Mutha F\*\*\*\* (BMF) Harley Davidson motorcycle exhaust, the baddest sounding pipe on the market. This BMF, formerly known as the "LMF" has great horse power for your big V-Twin or Milwaukee 8. This Harley Davidson motorcycle exhaust comes complete with a functional header collector. Our uniquely designed performance cone allows you to swivel the DBC tip in any direction you wish. Available in black or chrome.

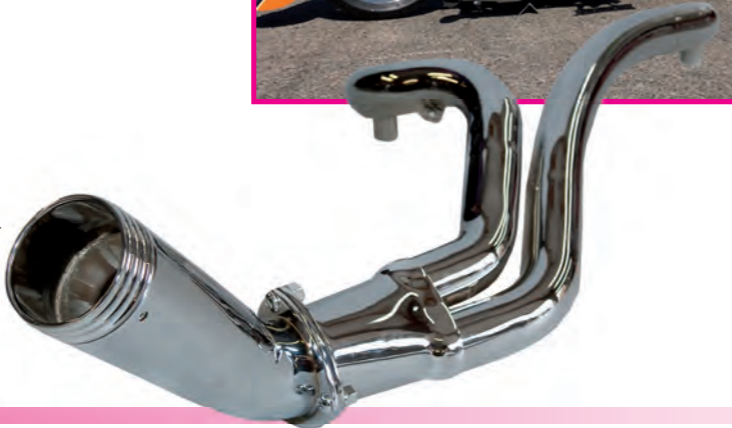

**Indian – Race Tech Series Scout Front Fender**  
This shorter fender and was designed to give your Scout, Scout 60 and Bobber a racier look while still using the body lines of your factory fender.



**Indian Scout Rear Fender The Flat Track TT Ass End 14 To 18**  
Let's go racing! Inspired by John Shope and his flat track racing with the Hooligans, he brings you this awesome ass end rear fender kit. Looking to give your bike that café or flat track look? Look no further. Made from our super strong NYB polymer, this Indian Scout rear fender gives you style, durability and a cutting edge race look just like John's race bike. This kit comes with everything you need, ass end rear fender, seat pan or a complete seat and tail light with LED license plate frame with mounting bracket. This is a game changer for your Indian Scout, Scout 60 and Bobber bike.





# DNA



# DNA



*Dna Specialty is an aftermarket manufacturer for over 30 years. Dna owns and operates factories that have allowed us to remain competitive in the manufacturing business. Dna has continuously supplied top of the line aftermarket parts for motorcycles to leading industry players throughout the world. As a participating dealer, you will receive the opportunity to show your customers all our current wheel styles, front ends and more.*



<http://dnaspecialty.com>



# DNA SPECIALTY



**Springer Front End**  
Available in Narrow Springer  
in Chrome or Black  
From 4" under to 2" over stock  
Or Vintage Springer  
in Chrome or Black  
From 4" under to 18" over stock



Springer Top Tree

**Accessories for Springer available**

- Top Tree
- Handlebar converter
- Risers
- Springer Shock
- Fender Tab Mount
- ...



Spring Shock Mount Kit  
Chrome or Black



Removable Fender Mounts  
Chrome or Black



Handlebar Converter



Handlebar Risers  
In 2, 4 or 6"  
Chrome or Black

**41 mm Billet Front End**  
in Chrome or Black  
From 2" under to 10" over stock



**62 mm Inverted Front End**  
in Chrome or Black  
From 2" under to 10" over stock

**5 3/4" Chopper Headlight**  
Available in Chrome or Black



**4 1/2" Tri Bar Headlight**  
Available in Chrome or Black



**7" L.E.D. Light**  
Available in Chrome, Gold or Black



**7" L.E.D. Bulb Bracket**



**4,5" L.E.D. SpoLight Set**  
Available in Black, Gold or Chrome



**Smooth or Elite Forward Controls**  
Available for up to 99 and 200 up  
in Chrome or Black  
In Standard or +2" extended



## Billet Wheels in 19 Design including Smoothie and most sizes and application to fit your builds !

In Chrome or Black finishes  
 Matched Pulleys in 60 Th, 70 Th, 72 Th, 65 Th And large 1" - 1 1/8", 1 1/2"  
 Matched Sprocket in 48 Th or 51 Th  
 Matched Rotors Front and Rear ... 11,5" and 11,8"  
 and on some design available also in 13"  
 Matched Air Filters



Wheels Sizes	
16 x 3,5"	18 x 10,5"
16 x 5,5"	18 x 13"
17 x 3,5"	19 x 2,15"
17 x 6,25"	19 x 3"
17 x 12"	21 x 2,15"
18 x 3,5"	21 x 3,25"
18 x 4,25"	23 x 3,75"
18 x 5,5"	26 x 3,75"
18 x 8,5"	30 x 4"

Beast Design



Icon Design



SS2 Design



Storm Design



Threat Design



C2 Design



Envy Design



Sprockester Kit



Brackester Kit



Crystal Design



Greed Design



Indian Scout Exhausts

Smoothie Design



Super Spoke Air Filter  
 Black or Chrome



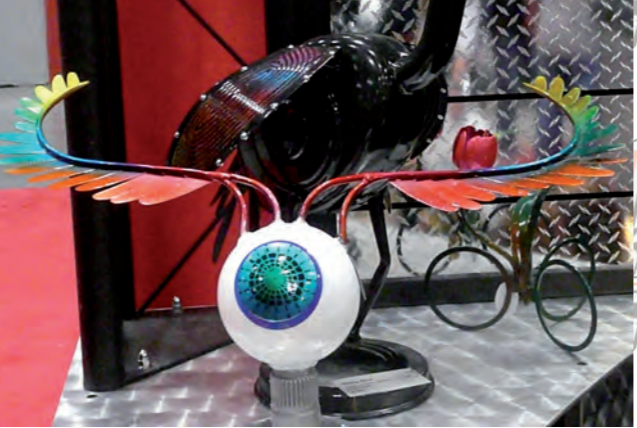

Founded in 1972 Dynojet Research Inc. is the world leader in the development and manufacturing of performance enhancement products and tools. Our fuel management and diagnostic products, coupled with our personalized services, give you the resources to maximize performance and increase efficiency. With over a decade of experience, Dynojet has relied on state-of-the-art technology to provide you with the best products available. Our philosophy stands behind the belief that our customers are number one. Individualized attention is given so that you can take full advantage of the products we offer. Because of this philosophy, we guarantee high credibility, consistency, and customer satisfaction. Here at Dynojet, we invite you to put our products to the test.





# DYNOJET



## Power Vision

Power Vision is the most powerful and quickest flash tuning device for Harley-Davidson® motorcycles in the market today. It is a performance tuner and data monitor that offers the latest flash tuning technology, data logging, and other industry exclusive features. The Power Vision can tune any fuel injected Harley-Davidson® motorcycle with the Delphi ECM, including 2018 models. The Power Vision Product Suite includes a full color touch screen flash device, built in AutoTune Basic Mode\*, vehicle interface cable, and WinPV (Windows PC based tuning application).

The Power Vision now fully supports the latest ECM calibrations that are found in the M8 2018 bikes, as well as the updated software levels for M8 2017 bikes. This also includes the popular new Softail equipped with the Milwaukee 8 engine!



**Power Vision for all CAN ECM Harley-Davidson Models**  
 3.5 24bit color TFT (touch screen) display with touch panel (16,777,216 colors)  
 Compact: 2.83"L X 3.97"W X .84"H.  
 Weather, shock, and vibration resistant enclosure - fully potted with silicone elastomer, and utilizes over molded cables with sealed cable connections  
 Integrated AMPS 4 hole threaded inserts for various mounting solutions (Dynojet recommends TechMounts)  
 USB mini-B weatherized- compatible with Windows XP, Vista, 7, and 10  
 Molex 8 pin connector-to-vehicle interface cable  
 Dynojet CAN-Link Expansion Port allows interfacing with other Dynojet products, such as the Wide Band 2 or AutoTune Module  
 2GB of internal memory provides a robust capacity for tune files and data logs  
**DY/PV-2 ... Power Vision for all CAN ECM Harley-Davidson Models Chrome**  
**DY/PV-2B ... Power Vision for all CAN ECM Harley-Davidson Models Black**

**Power Vision for All J1850 ECM Harley-Davidson Models**  
 3.5 24bit color TFT (touch screen) display with touch panel (16,777,216 colors)  
 Compact: 2.83"L X 3.97"W X .84"H. Click here to see a visual representation.  
 Weather, shock, and vibration resistant enclosure - fully potted with silicone elastomer, and utilizes over molded cables with sealed cable connections  
 Integrated AMPS 4 hole threaded inserts for various mounting solutions (Dynojet recommends TechMounts)  
 USB mini-B weatherized- compatible with Windows XP, Vista, 7, and 10  
 Molex 8 pin connector-to-vehicle interface cable  
 Dynojet CAN-Link Expansion Port allows interfacing with other Dynojet products, such as the Wide Band 2 or AutoTune Module  
 2GB of internal memory provides a robust capacity for tune files and data logs  
**DY/PV-1 ... Power Vision for All J1850 ECM Harley-Davidson Models Chrome**  
**DY/PV-1B ... Power Vision for All J1850 ECM Harley-Davidson Models Black**



## POWER VISION SHOP TUNER KIT

Dynojet now offers the Power Vision Tuner Kit that includes everything you need to start flash tuning Harley-Davidson® motorcycles.

This comprehensive kit is perfect for small independent shops or franchised dealers looking to minimize the headaches and maximize profits.

This kit provides everything necessary to tune multiple bikes using just one Power Vision and AutoTune Pro Module! Included is a Power Vision, AutoTune Pro Module, and all necessary cables in order to tune J1850 or CAN models.

**DY/PV-TK3 ... Power Vision Tuner Kit**



## POWER VISION Handlebar mount kit

Get your Power Vision handy with this Handlebar mount Kit  
 - Chrome or Black for Dynojet Power Vision / PV, PVCX, For 7/8" to 1 1/4" diameter handlebars.  
 \*Will not fit handlebars 1.5" or larger in diameter.



## Dynojet Shifter kit

Normally during "up shifting" you must roll off of the throttle and pull in the clutch to engage the next higher gear. In racing split seconds count. Rolling off the throttle, even slightly, slows your times and can be the difference between winning and losing. The Dynojet Quick Shifter (DQS) allows full throttle, clutch less shifting. This is done by momentarily cutting the fuel and or ignition, which unloads the transmission. During this time, the rider can shift up to the next gear without rolling off the throttle or using the clutch.

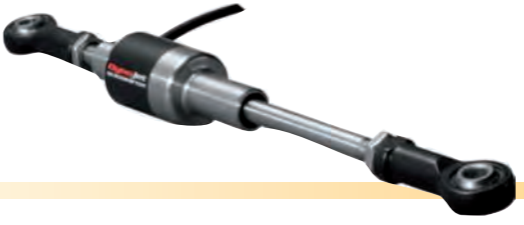



### Power Vision WideBand Power Vision CX

The new Wideband CX plugs into the vehicle's diagnostic port and directly integrates AFR data from the included O2 sensors with the OEM databus. When used in conjunction with the Power Vision CX you can view and datalog wideband O2 data along with custom channels directly from the diagnostic port of the vehicle. The logs are stored in the PVCX memory and can easily be downloaded for review in the Dynojet's Power Core software Suite .

The Wideband CX is a plug and play kit with no extra cables for power , ground and signal that are usually associated with wideband controllers . Wideband CX ensures real-time wide band O2 AFR accuracy with negligible latency and avoids any signal offset issue with its industry first , innovative design .



- GIVES END USERS COMPLETE CONTROL OF THEIR CALIBRATION
- START WITH THE ORIGINAL CALIBRATION, OR MODIFY / EDIT EXISTING CALIBRATIONS
- MANAGE AND SEND TUNE FILES TO THE POWER VISION CX
- REAL-TIME CELL TRACING
- MONITOR AND LOG SUPPORTED DATA CHANNELS FROM THE ECU
- TUNE LOCK OPTION TO PROTECT UNAUTHORIZED SHARING

**NOTICE**

CAUTION: Do not attempt to modify the sensor or the wiring. The sensor is a precision instrument and should be handled with care. The sensor is not to be used for any other purpose than the intended use. The sensor is not to be used for any other purpose than the intended use. The sensor is not to be used for any other purpose than the intended use.

# Dynojet

## Pro Stealth Extraction Interface Kit



### TIRED OF WELDING BUNGS, DESTROYING BAFFLES, OR OTHERWISE FINDING AWAY TO GET AN ACCURATE EXHAUST GAS SAMPLE FOR TUNING PURPOSES?

Dynojet has the answer with its new Stealth Extraction Interface Kit. This kit allows you to discretely gain access to an exhaust gas sample when tuning on a Dynojet dyno. The new O2 wideband sensor sampling block does not require the use of the DynoWare RT AFR Module pump and allows for multiple sensor positions for quicker installations and access to hard to reach locations. Whether you're tuning with a Power Commander or Power Vision, this kit will speed up the tuning process. When finished, the reference port is sealed with a copper washer and button head bolt for a clean, finished look.



### THREE KITS ARE AVAILABLE:

74200000



#### PRO STEALTH EXTRACTION INTERFACE KIT WITH RIV-NUT TOOL

**INCLUDES:** PROFESSIONAL GRADE RIV-NUT TOOL, DRILL BIT, 50 PIECES OF CONSUMABLES (BOLTS, WASHERS, RIV-NUTS, ETC), AND BILLET MANIFOLD AFR BLOCK AND STUD.

77000028



#### PRO STEALTH EXTRACTION INTERFACE UPGRADE KIT

**INCLUDES:** BILLET MANIFOLD AFR BLOCK AND STUD ASSEMBLY ONLY.

74200001



#### PRO STEALTH EXTRACTION INTERFACE KIT

**INCLUDES:** 50 PIECES OF CONSUMABLES (BOLTS, WASHERS, RIV-NUTS, ETC), AND BILLET MANIFOLD AFR BLOCK AND STUD.







*Easyriders was founded in 1982, the leading company of customizing parts for Harley-Davidson and Metric Cruisers in Japan over 35 years. It is a first company as launching aftermarket parts for Harley-Davidson advanced into Europe. Proudly make their parts with high quality and outstanding / state-of-the-art design from Japan. Nitro-Heads is the brand of their parts for Ducati Scrambler, Triumph Modern Classics and Yamaha sr.*

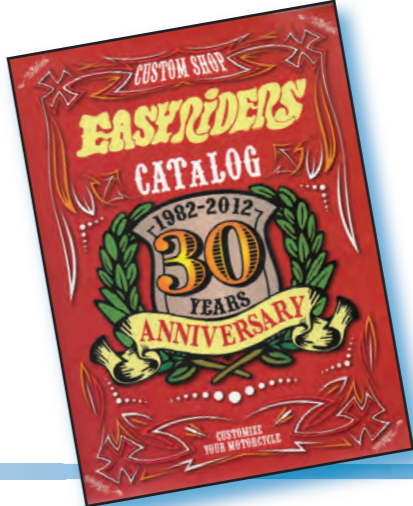

## All the parts from Easyriders Japan are available !



**ER/H1322**  
side mount speedometer bracket 04up XL



**ER/H3245**  
hi-mount fuel tank bracket kit 04up XL



**ER/3575**  
front mud guard (Universal)



**ER/3576**  
front mud guard for springer model



**ER/H5176**  
license plate relocation kit 13-17 FXSB Breakout



**ER/H3535**  
short front fender (XL1200X Forty-Eight)



**ER/H3508**  
short bobber rear fender (04-06 / 10up XL)



**ER/H3511**  
short fat bob rear fender (04-06 / 10up XL)



**ER/H3523**  
center ribbed fender (04-06 / 10up XL)

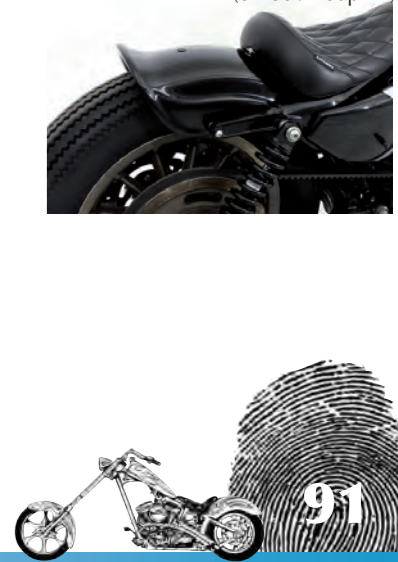



**ER/H3538**  
bikini cowl kit  
(11up Forty-Eight  
16up Roadster)



**ER/H2399**  
solo seat mounting kit <solid mount>  
(04-06 / 10up XL)



**ER/H3539**  
bikini cowl kit  
(06up Dyna)



**ER/H2286**  
Softail solo seat mounting kit  
00-06 T/C



**ER/H2394**  
solo seat mounting kit  
(08up T/C Softail)

**ER/0075 ... Chrome**  
**ER/0075-BK ... Black**  
rabbit bar (stainless / 1inch / w/ dimple)



**ER/0717 ... Chrome**  
**ER/0717-BK ... Black**  
10inch attack bar (stainless / 1inch / w dimple)



**ER/H2182**  
Softail solo seat mounting kit <EVO>



**ER/H0374**  
vertical single gunfighter seat  
(04up XL)



**ER/0760-BK ... Black**  
loose bar (steel / 1inch / w dimple)



**ER/2248**  
EZ pad with suction cups (black)



**ER/2374-BK**  
SF solo seat DX vertical





# E.M.D.

Esteves Motorcycle Design

E.M.D. Esteves Motorcycle Design

Esteves Motorcycle Design

E.M.D. Esteves Moto

design



Motorcycle Design

E.M.D. Esteves Motorcycle Design

ign

E.M.D. Esteves Motorcycle Design

E.M.D. Esteves Moto

sign

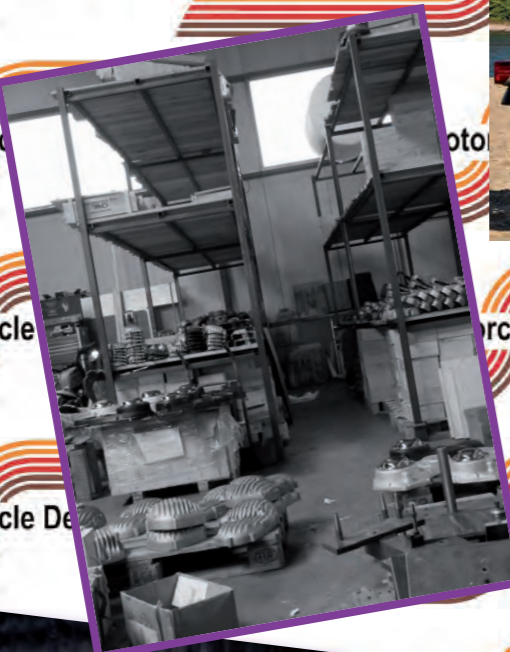

sign

E.M.D. Esteves Motorcycle De

Motorcycle

E.M.D. Esteves Motorcycle Design



gn



Esteves Motorcycle Design

Esteves Motorcyc

design



design

Motorcycle Design

E.M.D. Esteves Motorcyc

[www.estmd.com](http://www.estmd.com)



### *Killer Parts For Your Iron Horse*

*The better choice to get the BadAss look with your bikes !  
From a small machine shop in France a wide range of retro style parts have spread the world.*

*The ribbed look is offered for many different cast pieces to give your bike that 60's vintage touch so fashionable these days.*

*If you are nostalgic of these small production hit parts of the choppers that made this style a one of a kind like genre, then E.M.D. brings you what it takes.*

*Some of these parts are your only chance to get a non far east made replacement for that long discontinued by Harley busted piece you were not hoping to get like a 77-90 Ironhead Sporty primary cover.*

*Also headlamps, air filters with the cast grain and finned look.  
Four finishes, Raw, Black, Semi Polished and Black Out available.  
Let these parts help you to achieve that look you're dreamin' of.*





**RIBSTERS** Rocker Box covers, Sprocket covers, Primary covers Gear Box covers and Cam covers "Ribbed" Snatch Design directly inspired by the finned covers from the golden age of Choppers will radically change the look of your engine. Manufactured in die cast aluminum, CNC milled gasket surface Of course they will not go faster but it will be a guaranteed "badass" look!



Ribbed Style Black



Iron Style Black Cut Evo



Ribbed Style Black Twin Cam

**Rocker Cover Sportster**

**Sportster Before 2004 Ribbed (pair)**  
EMD/RCXL-RR ... Raw finish  
EMD/RCXL-RSP ... Semi Polished  
EMD/RCXL-RB ... Black  
EMD/RCXL-RBC ... Black Cut

**Sportster Before 2004 Shovel (by unit)**

EMD/RCXL-SHR ... Raw finish  
EMD/RCXL-SHSP ... Semi Polished  
EMD/RCXL-SHB ... Black  
EMD/RCXL-SHBC ... Black Cut

**Sportster Before 2004 Iron (by unit)**

EMD/RCXL-ISP ... Semi Polished  
EMD/RCXL-IBC ... Black Cut

**Sportster Before 2004 XR (by unit)**

EMD/RCXL-XRR ... Raw  
EMD/RCXL-XRBC ... Black Cut

**Sportster After 2004 Ribbed (pair)**

EMD/RCXLI-RR ... Raw finish  
EMD/RCXLI-RSP ... Semi Polished  
EMD/RCXLI-RB ... Black  
EMD/RCXLI-RBC ... Black Cut

**Sportster After 2004 Shovel (by unit)**

EMD/RCXLI-SHR ... Raw finish  
EMD/RCXLI-SHSP ... Semi Polished  
EMD/RCXLI-SHB ... Black  
EMD/RCXLI-SHBC ... Black Cut

**Sportster After 2004 Iron (by unit)**

EMD/RCXLI-ISP ... Semi Polished  
EMD/RCXLI-IBC ... Black Cut

**Sportster After 2004 XR (by unit)**

EMD/RCXLI-XRR ... Raw  
EMD/RCXLI-XRBC ... Black Cut

**Rocker Cover Big Twin**

**Evo 1340 Ribbed (pair)**

EMD/RC13-RR ... Raw finish  
EMD/RC13-RSP ... Semi Polished  
EMD/RC13-RB ... Black  
EMD/RC13-RBC ... Black Cut

**Evo 1340 Shovel (by unit)**

EMD/RC13-SHR ... Raw finish  
EMD/RC13-SHSP ... Semi Polished  
EMD/RC13-SHB ... Black  
EMD/RC13-SHBC ... Black Cut

**Evo 1340 Iron (by unit)**

EMD/RC13-ISP ... Semi Polished  
EMD/RC13-IBC ... Black Cut

**Twin Cam Ribbed (pair)**

EMD/RCTC-RR ... Raw finish  
EMD/RCTC-RSP ... Semi Polished  
EMD/RCTC-RB ... Black  
EMD/RCTC-RBC ... Black Cut

**Twin Cam Sherman (pair)**

EMD/RCTC-SHR ... Raw finish  
EMD/RCTC-SHB ... Black

GearBox 5 Raw



GearBox 6 Black



Sherman Style Black Twin Cam



Ribbed Style Black Cut Twin cam

**GearBox Cover FXR**

EMD/GB5FXR-RR ... Raw finish  
EMD/GB5FXR-RSP ... Semi Polished  
EMD/GB5FXR-RB ... Black  
EMD/GB5FXR-RBC ... Black Cut

**5 Speed Evo / Twin cam**

EMD/GB5-RR ... Raw finish  
EMD/GB5-RSP ... Semi Polished  
EMD/GB5-RB ... Black  
EMD/GB5-RBC ... Black Cut

**6 Speed Twin cam**

EMD/GB6TC-SHR ... Raw finish  
EMD/GB6TC-SHSP ... Semi Polished  
EMD/GB6TC-SHB ... Black  
EMD/GB6TC-SHBC ... Black Cut

**Sprocket Cover**

**Sportster 1991-2003 Ribbed**  
EMD/SCXL-RR ... Raw finish  
EMD/SCXL-RSP ... Semi Polished  
EMD/SCXL-RB ... Black  
EMD/SCXL-RBC ... Black Cut

**Sportster 2004-2015 Ribbed**

EMD/SCXLI-RR ... Raw finish  
EMD/SCXLI-RSP ... Semi Polished  
EMD/SCXLI-RB ... Black  
EMD/SCXLI-RBC ... Black Cut



Sprocket Cover Black Sporty



Cam Cover Ribbed Black Sporty



Primary Cover Raw Sporty Iron 71-77



Primary Cover Black Cut FXR

**Primary Cover Sportster**

**Sportster Iron 1971-1977**  
EMD/PCI71-RR ... Raw finish  
EMD/PCI71-RSP ... Semi Polished  
EMD/PCI71-RB ... Black  
EMD/PCI71-RBC ... Black Cut

**Sportster Iron 1977-1990**

EMD/PCI77-RR ... Raw finish  
EMD/PCI77-RSP ... Semi Polished  
EMD/PCI77-RB ... Black  
EMD/PCI77-RBC ... Black Cut

**Sportster 1991-2003 Ribbed**

EMD/PCXL-RR ... Raw finish  
EMD/PCXL-RSP ... Semi Polished  
EMD/PCXL-RB ... Black  
EMD/PCXL-RBC ... Black Cut

**Sportster 2004 Up Ribbed**

EMD/PCXLI-RR ... Raw finish  
EMD/PCXLI-RSP ... Semi Polished  
EMD/PCXLI-RB ... Black  
EMD/PCXLI-RBC ... Black Cut

**Sportster 2004 Up Trackster**

EMD/PCXLI-TR ... Raw finish  
EMD/PCXLI-TB ... Black

Primary Cover Ribbed Black Cut Sporty



Primary Cover Trackster Raw Sporty



**Cam Cover Twin cam**

**For Twin Cam**  
EMD/CCTC-RR ... Raw finish  
EMD/CCTC-RSP ... Semi Polished  
EMD/CCTC-RB ... Black  
EMD/CCTC-RBC ... Black Cut



Cam Cover Ribbed Style Black Cut Twin Cam



Cam Cover Knuck Style Black Cut Sporty



Primary Cover Black Touring

**Primary Cover Big Twin**

**For FXR Ribbed**  
EMD/PCFXR-RR ... Raw finish  
EMD/PCFXR-SP ... Semi Polished  
EMD/PCFXR-B ... Black  
EMD/PCFXR-BC ... Black Cut

**Touring Twin Cam 2007-2013 Ribbed**

EMD/PCTCT-RR ... Raw finish  
EMD/PCTCT-RSP ... Semi Polished  
EMD/PCTCT-RB ... Black  
EMD/PCTCT-RBC ... Black Cut

**Dyna 2007-2011 Ribbed (mid controls)**

EMD/PCTCD-RR ... Raw finish  
EMD/PCTCD-RSP ... Semi Polished  
EMD/PCTCD-RB ... Black  
EMD/PCTCD-RBC ... Black Cut

**Softail 07-2011 Up Ribbed (forward controls)**

EMD/PCTCS-RR ... Raw finish  
EMD/PCTCS-RSP ... Semi Polished  
EMD/PCTCS-RB ... Black  
EMD/PCTCS-RBC ... Black Cut



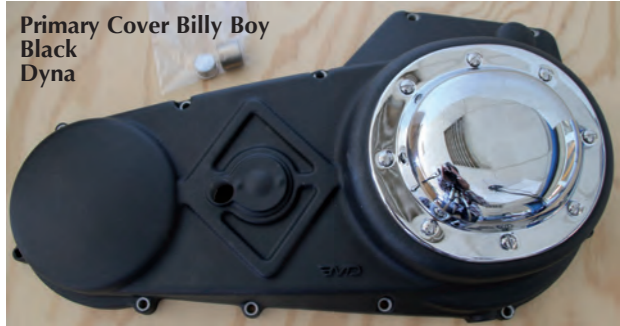

Primary Cover Billy Boy  
Black  
Dyna

**Billy Boy Primary Cover**  
The EMD Billy Boy Design was directly inspired by the sheet metal primary covers from the famous Billy's Bike from the Film Easy Riders. The Golden Age of the Panhead and Knucklehead Bobbers & Choppers.

**Primary Cover Billy Boy Big Twin**

- For Softail Evo & Twin Cam (Forward controls) 89-06**  
EMD/PC13TCS-BBR ... Raw finish  
EMD/PC13TCS-BBB ... Black
- For Dyna Evo & Twin Cam (Mid controls) 91-05**  
EMD/PC13TCD-BBR ... Raw finish  
EMD/PC13TCD-BBB ... Black
- For Softail Twin Cam (Forward controls) 2007 Up**  
EMD/PCTCS-BBR ... Raw finish  
EMD/PCTCS-BBB ... Black
- For Dyna Twin Cam (Mid controls) 2006 Up**  
EMD/PCTCD-BBR ... Raw finish  
EMD/PCTCD-BBB ... Black



**Primary Cover Touring JD Twin Cam**

For Touring Twin Cam 07-13  
EMD/PCTCJD-RBC ... Black Cut



Primary Cover JD  
Touring



Primary Cover Billy Boy  
Raw  
Softail

**Vitamin A & C Headlight Housing**  
Fits all late 5 3/4inch Inserts an trim rings like Sportster and Dyna, Ultracool Vintage Look directly inspired by the golden age of the Californian Choppers and Bobbers This new Head Lamp Housing will please all those who love the simplicity of raw Vintage parts.



Headlamp Vitamin A

**Headlamp Vitamin A**

- Vitamin A**  
EMD/HLVA-R ... Raw finish  
EMD/HLVA-SP ... Semi Polished  
EMD/HLVA-B ... Black

**Headlamp Vitamin C**

- Vitamin A**  
EMD/HLVC-R ... Raw finish  
EMD/HLVC-SP ... Semi Polished  
EMD/HLVC-B ... Black



Headlamp Vitamin C



**Vortex Racing Air Filter**  
Fits all Sportster XL models from 1986 up / all Big Twin from 1984 -2015 with CV Carburetor or EFI (except TBW models) Venturi thermoformed Lexan insert for the best performance and flow intake.

**Ultracool Racing Look** directly inspired by the Top Fuel Dragsters on the Dragstrip " Old-School " design, basic and brutal

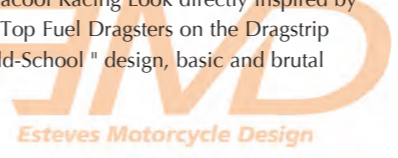

**Air Filter Vortex Racing**

- Air Filter Racing**  
EMD/AFR-R ... Raw finish  
EMD/AFR-BC ... Black Cut



**Electric Kick**

- Sportster 1991-2003**  
EMD/KEXL-RR ... Raw finish  
EMD/KEXL-RB ... Black
- Sportster 2004-2015**  
EMD/KEXLI-RR ... Raw finish  
EMD/KEXLI-RB ... Black



**Wheel Disc Toy Sold in Pair**

- Wheel Disc**  
EMD/TOY16-R ... Raw finish  
EMD/TOY16-B ... Black  
EMD/TOY17-R ... Raw finish  
EMD/TOY17-B ... Black  
EMD/TOY19-R ... Raw finish  
EMD/TOY19-B ... Black



**Wheel Discs Covers for 16, 17 & 19 inch Wheels**  
Toy design  
Manufactured from Aluminium sheet metal



- Bombshell Fork Short 39**  
**Fork Tube**  
EMD/BSS-39R ... Raw finish  
EMD/BSS-39SP ... Semi Polished  
EMD/BSS-39B ... Black  
EMD/BSS-39BC ... Black Cut



- Bombshell Fork Long 39**  
**Fork Tube**  
EMD/BSL-39R ... Raw finish  
EMD/BSL-39SP ... Semi Polished  
EMD/BSL-39B ... Black  
EMD/BSL-39BC ... Black Cut



- Bombshell Fork Short 41**  
**Fork Tube**  
EMD/BSS-41R ... Raw finish  
EMD/BSS-41SP ... Semi Polished  
EMD/BSS-41B ... Black  
EMD/BSS-41BC ... Black Cut

Directly inspired by the Design of the European telescopic forks from the golden age of the choppers, and for all fans of the "Vintage" style! With this BOMBSHELL fork head EMD offers you today a completely new and innovative product, mixing Factory, British and German style.

**Fork Tube Bombshell 49**

- Fork Tube**  
EMD/FTC-B49R ... Raw finish  
EMD/FTC-B49SP ... Semi Polished  
EMD/FTC-B49B ... Black  
EMD/FTC-B49BC ... Black Cut





# HardDrive

AMERICAN V-TWIN PRODUCTS



*Welcome to HardDrive V-Twin Products,  
an industry leader in aftermarket Harley motorcycle parts.  
HardDrive is the V-twin division of Western Power Sports (WPS),  
a family owned distribution business since 1960. We currently operate six warehouses nationwide  
with more than 1 million sq./ft. of stocking capabilities and over 20,000 HardDrive part numbers  
to ensure our customers are accommodated accordingly.*

*Our HardDrive team consists of active players from within the V-twin industry, who bear  
a strong emotional drive for the success of our business and to keep the motorcycle community growing.  
As a company, our vision was grafted from innovation and creativity to help bring together  
a fresh marketing campaign, coupled with a unique product offering that was like no other.  
We pride ourselves on our products, the partnerships with our 200+ vendors  
and our outstanding customer service.  
We want to thank you for your support and wish you all a prosperous year!*





# HARD DRIVE

**Hardrive**  
HardDrive has partnered up with some of the most refined factories and companies to produce the HardDrive branded product line to ensure our dealers have the best product for the best price.

**HardDrive**  
AMERICAN V-TWIN PRODUCTS

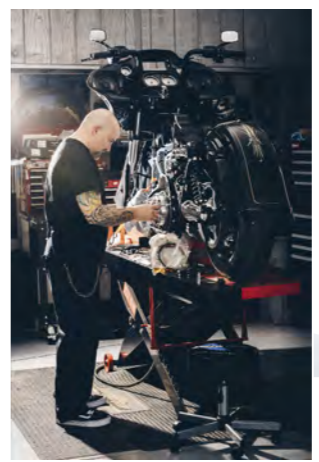

**PATHFINDER**  
Pathfinder saw the issue of lack of quality in the industry and created a product that uses better optics and LED chips to power the light and the end result comes close to H.I.D like performance!  
The projector design intensifies and projects the light source farther and wider down the road for a safer night time ride.  
Available in full lens assembly replacement or simple H4, H11 bulb replacements.





## LYNDALL BRAKES

Lyndall Wheels combines cutting-edge design and beautiful craftsmanship in its truest form. The Chrome or Black B-52 and TT Tracker wheel styles are both stronger and lighter than stock; improving the performance, functionality, and beauty of your bike like no other can. Matching pulleys, sprockets, and rotors are available separately to complete the package and all are Made in the USA.



## ROOKE

Jesse Rooke has a long history in motorsports and custom bike building and his racing style is expressed through the custom colored bolt on accent pieces, the aggressive bear trap style floorboards or the simple lines of his billet risers. These high-quality items are all Made in the USA



## DRAGONFLY

Dragonfly's new injected-molded LPRTM composite made '14-Up Style Batwing Fairings and FXRP Fairings for Dyna models, come ready for stereos and speaker assemblies, have stainless steel mounting brackets to assure stability against vibration and all with a clean, classic look. All Made in the USA.



## AQUATIC AV®

products with a watertight reputation

### AQUATIC AV

Launch your music capabilities with a plug-n-play, state of the art, Aquatic AV Bluetooth Stereo or Speaker Stereo Kit. The waterproof stereo has a built-in 288W amplifier to intensify your tunes, provides a compartment behind the faceplate in which you can store and charge your device via USB while playing and utilize all stock handlebar controls for ease of use.





# HEADWINDS

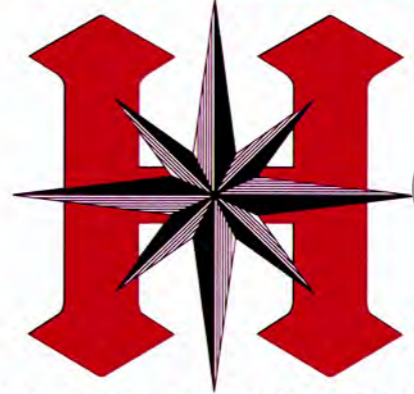

## CYCLE PRODUCTS

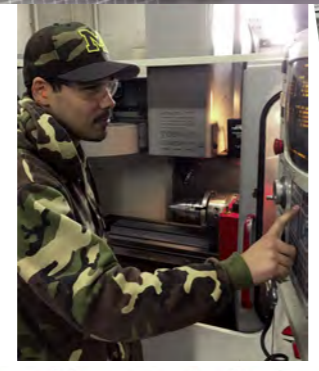

# HEADWIN

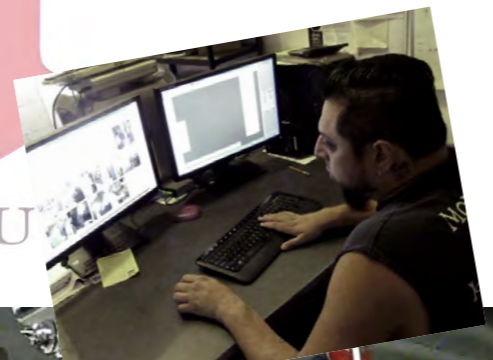

*Since 1992, Headwinds has proudly offered the finest quality lighting to Motorcycle, Hot Rod & Big Rig builders who demand the best. Our headlights feature smooth, non-wavy surfaces with mirror finishes.*

*Innovations that do away with exposed rivets, bolts and flanges like threaded housings with screw-in bezels and billet brackets with hidden fasteners are only part of what makes our product line the finest available anywhere. Headlight Housings are offered in 7", 5-3/4", 4-1/2" and 2" models. Turn Signals are offered in 3", 2", 1-3/8" and 1" models.*

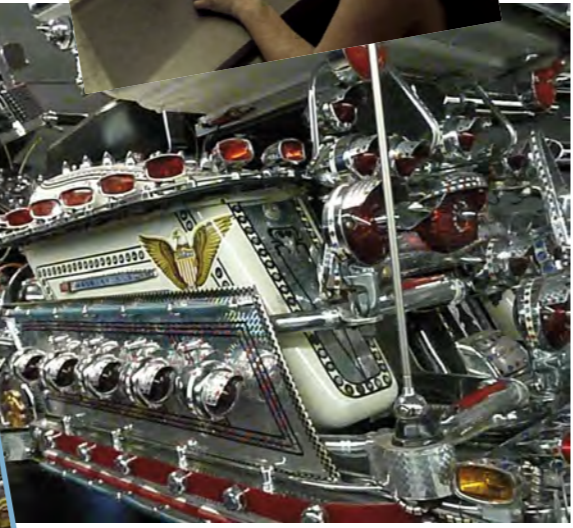
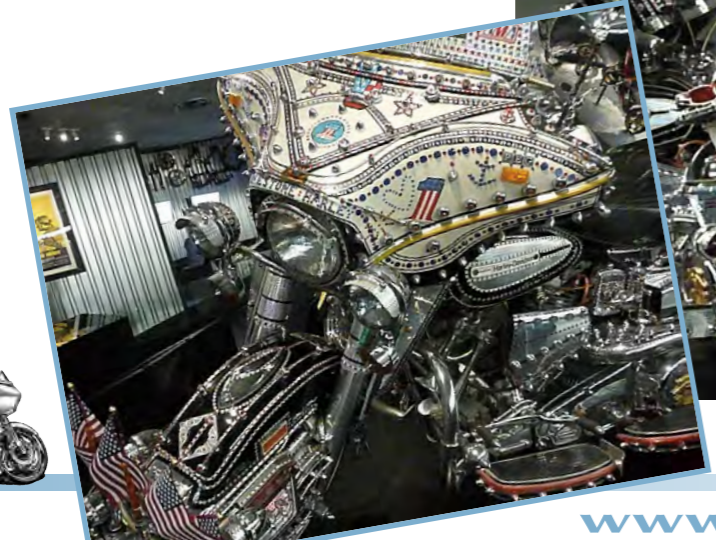



# HEADWINDS



## Leading the Custom Headlights Industry since 1992

Generally, any combination of housing; style, size, groove pattern & mount is available in chrome black and polished aluminum. Mounts, hardware and lamps are also available making installation a snap. Custom application is our tradition, so don't hesitate to e-mail or call us about your project. With over 100 different headlight models, no one can match our selection, style and service.



**4-1/2" Spotlight Housing**  
Our 4-1/2" Spotlights are ideally suited to match a 7" Headlight or Nacelle Bezel when using our welded Spotlight Bar or stock HD Spotlight Bar.

**FEATURES:**

- Spun billet aluminum housing
- Fully machined with a non-wavy, mirrored finish
- Screw-in bezel with locking feature
- Traditional rounded visor cut into the housing
- Supplied with 3/8" stud, drilled for wire passage
- Low profile, polished and chromed spherical washer supplied
- Fits all SAE lamps
- Made in the USA by Headwinds, Inc.



**4-1/2" Bullet/Rocket Spotlight Bar - FLSTS Heritage Springer**  
Looking for a longer, sleeker looking Heritage Springer? Our billet light bar visually lowers and lengthens your bike for a streamlined look!

**FEATURES:**

- Billet aluminum
- Mounts to the top shock bushing and to the Springer girder for stability
- Mounting hardware included
- Spotlights not included
- Made in the USA by Headwinds, Inc.



**7" Headlight Bezel**  
MAKE A STATEMENT WITH OUR MARIAH BEZEL ON YOUR BAGGER!

**FITS:**

- FLH - '85-'13
- FLHR Road King - All
- FLHT Electra Glide - to '13
- FLHX Street Glide - to '13
- FLST Fat Boy, Heritage (with Harley-Davidson or after-market nacelles) - All

DOES NOT FIT '14-on Bikes with Fairings



**4-1/2" Bullet Spotlight Bar**  
Available for FLH, FLST,

- Overall width of bar: Approximately 17.5"
- Billet Aluminum, machined, welded and polished
- Made in the USA by Headwinds, Inc.

Available in Chrome, Polished or Gloss Black .  
Ask for your model !



**7" Vampire Concurs Rocket**  
in Chrome or polished  
Also in 5 3/4" in Chrome, Polished, Gloss or Flat Black & 4,5 in Chrome or Polished



**7" Vampire Concurs Rocket Revolver**  
in Black Cut  
Also in 5 3/4" & 4,5d



**7" Vampire Concurs Rocket Flame**  
in Black, Chrome or polished  
Also in 5 3/4" and 4,5" in Chrome, Polished



**5 3/4" Mariah Rocket**  
in Gloss Black, Chrome or polished



**5 3/4" Mariah Rocket Viking Groove**  
in Black, Black & Chrome, Chrome or polished



## 7" , 5 3/4" and 4,5" Headlamps

A large choice including Black Dot Tri Bar, Ice Diamond, ...



7" Headlamp & 5 3/4" Ice Diamond Cut



7" Headlamp 5 3/4" & 4,5" Black Dot Tri-Bar - Diamond or Wave Cut



7" Headlamp & 5 3/4" Skull Ice Diamond Cut



7" Headlamp 5 3/4" & 4,5" Blue Dot Tri-Bar - Diamond or Pie Cut



7" Headlamp 5 3/4" & 4,5" Maltese Cross Wave Cut



7" Headlamp & 5 3/4" Skull Ice Diamond Cut



7" Headlamp 5 3/4" Candle Power in 60/55w and 7" also available in 100/55w



7" Headlamp With LED Turn Signal  
No need for separate turn signals! This Dynamic Snake Eye lamp has a built-in, clear lens LED turn signal!

## ATTENTION ROAD GLIDE OWNERS!

LED Lamps for your FLTR!  
Easy-to-install, one piece.  
FITS: FLTR - Road Glide ('98-'13)



5-3/4" Headlamp Assembly - LED - FLTR Road Glide - Hi/Lo



**FEATURES:**

- PLUG & PLAY! (x2)
- 60W high beam (x2)
- 30W low beam (x2)
- 3,500 Lumens high beam (x2)
- 2,000 Lumens low beam (x2)
- Color Temperature: 6000K
- Clear Lens
- UV-resistant polycarbonate lens
- DOT approved

## 5 3/4" Headlight grill

A large choice with several finition ...  
Black Cut, Black, Chrome, Polished, Brass ...

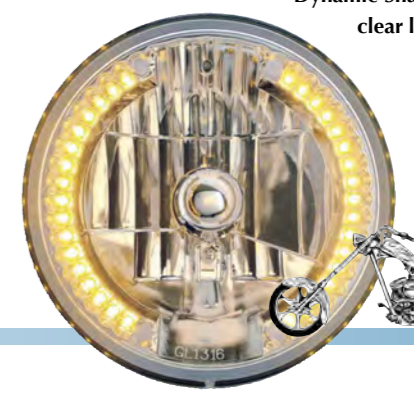



# HEADWINDS



### Headlight - Skull

This headlight produces more intense light than a standard single lamp filling the road! Due to the construction of this headlight, the eyes (low beam) hit the road and serve as the primary light. The mouth (high beam) shines light down to the ground in front of the bike.

Available in Chrome, Polished, Black Chrome, Raw, Flat Black



### FEATURES:

- Recommended connection:
  - Lo-Beam - Eyes - 50W 2" MR16 lamp
  - Hi-Beam - Mouth - lamp with 55W H3 bulb
- Jaw is adjustable for a custom look
- Headlight mount is 1" square steel tube moves Skull 3-1/8" forward, manufactured by Headwinds (supplied)
- 7/16" hardware is used to bolt the Skull to the mount (supplied)
- 3/8" hardware is required to bolt mount to your lower tree (sold separately)
- Made of cast aluminum. Some inherent pits, inclusions or holes may be visible
- Dimensions: 8-1/2" (H) x 5" (W) x 7" (D)
- Weight: 6.25 lbs.
- Not DOT approved
- Made in the USA. Cast by Skull Enterprises, finished by Headwinds

### Headlight mount

Available for most bikes in several finishes. Different models and sizes, for bullet or rocket headlight.

Available in Chrome, Polished, Black Chrome, Raw, Flat Black

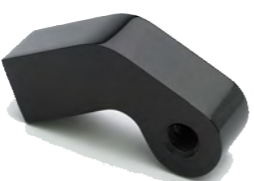

### 4-1/2" Spotlight Grills - For Stock FL Spotlights - Chrome (pair)

A truly unique look, our 4-1/2" grills match our 7" headlight grills blending with your stock set-up.

FITS STOCK 4-1/2" SPOTLIGHTS ON:

- FLHR - Road King (Stock)
- FLHT - Electra Glide (Stock)
- FLSTC - Heritage Classic (Stock)
- FLSTN - Heritage Nostalgia (Stock)

### FEATURES:

- Vertical "Mercury-style" grill bezel bars
- Fully machined
- 6061-T6 billet aluminum housing
- Replaces FLST stock beauty ring
- Made in the USA by Headwinds, Inc.



### Fairing Trim - FLHT, FLHX Stock Fairing (to '13)

Grooved - Polished Aluminum

FITS:

- FLHT Electra Glide (to '13)
- FLHX Street Glide (to '13)

### FEATURES:

- For use with your stock fairing
- Trim is designed to match the profile of your fairing
- Machined from billet aluminum
- Hardware Included
- Made in the USA by Headwinds, Inc.



### 4-1/2" Mariah Clamp Ring (aka Beauty/Trim Ring) - For Stock H-D Spotlights - Chrome (pair)

A truly unique look, our 4-1/2" grills match our 7" headlight grills blending with your stock set-up.

FITS STOCK 4-1/2" SPOTLIGHTS

### FEATURES:

- Matches our 7" Mariah Headlight Bezel
- Easy to install
- Replaces stock trim ring (our ring does not go over the stock ring)
- CNC machined 6061-T6 billet aluminum
- 2-1/8" long with 1" traditional rounded visor (top)
- 1-3/8" long (bottom)
- Traditional rounded visor cut into bezel
- Hardware included
- Made in the USA by Headwinds, Inc.



### 2" LED Turn Signal - Vampire Concours Rocket Smooth - FL Rear - Chrome (pair)

LOAD EQUALIZERS ARE REQUIRED for LED turn signals.

ADD BRAKE TO RUNNING AND TURNING use Illuminator

REAR TURN SIGNAL LENS COLOR

Federal law requires:

RED Lenses & bulbs when used as turn signals and running lights.

AMBER Lenses & bulbs when used as turn signals only.

### FEATURES:

- Sold in pairs
- Uses 41 Amber LED bulbs in a circular pattern
- All 41 bulbs stay lit, high and low intensity differentiates between turning and running
- Mounts on rear light bar located under tail light
- 3/8-16 x 1" hex head cap screw supplied (drilled for wire feed)
- CNC machined with a non-wavy, mirrored finish from 6061-T6 billet aluminum
  - "Spikey" pointed visor cut into the housing
- Housing is internally threaded and features a screw-in bezel that provides a clean, seamless look
  - Made in the USA by Headwinds, Inc.

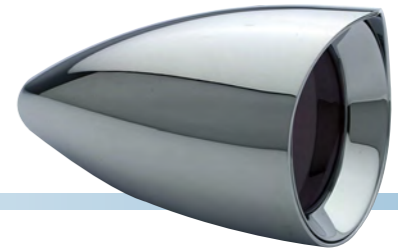
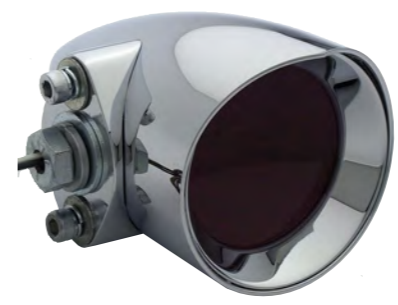



# HEARTLAND USA

Fender Conversions - Motorcycle Accessories



*I'm proud to celebrate another year of developing aftermarket products for Harley-Davidson motorcycles, based on design, innovation and quality. In an industry that exists almost exclusively for the purpose of fulfilling dreams, those who appreciate the value of synergy between quality, design and innovation along with a personal support team of individuals that stand behind the product will recognize Heartland USA as a brand leader in the industry today.*

*Check out our website for the launching of the new Sport Chop and Heart-Break kits, as well as our full product line of Conversions, quick release second seats, Ride Rack and Rest, wheels, tires, travel bags, plate holders, Hell Bent pipes – everything you need to customize your ride. Remember... Heartland USA - The Ultimate Custom Experience for your Harley-Davidson!*





# HEARTLAND USA



**Bobber Kit**  
From 180 - 200 and up to 250



**Direct Bolt On Kit For Softail's ... Dyna's ... Sporty's**  
3 lengths of fenders ... your choice !  
Optional struts led lights and turn signal  
Different finishes for the Struts



**Optional accessories for our kits**



Passenger Seat with Sissybar

Rear Side Bags



**SportChop Kit**



Before - After



200 Tire kit or 240 or 280 for Dyna !



Ride Rack & Rest leather



GearBag Designed to fit our Ride Rack & Rest



For the Softails ... From Stock  
180 or 200 Rear Tire  
also 250 Rear tire kit  
... up to 280 for the Breakout and Rocker





## A large range of accessories Heartland USA

Rear Plate Holder in different finishes and different mount possibility like : Swingarm, rear axle or passenger pegs



Front fenders



Fork brace



Fork clamps



Tank Lifters for an aggressive look



TurnSignal mirrors in different finishes



Billet Taillights and Turn Signals in different finishes



Rear Curved Passenger pegs

## All wheels designs from Colorado Custom Wheels - Renegade Wheels or Performance Machine available on special order



**USA MADE RENEGADE WHEELS**  
*Biker Motorcycle Wheels*





MOTORCYCLE  
PRODUCTS



*Image Motorcycle Products is the only manufacturer in the motorcycle industry offering art designed accessories inspired by biker, fantasy, middle age and mythology spirit produced one piece at a time like jewelry. Cast in aerospace quality stainless steel every piece is highly polished for a deep and durable shine that won't peel off.*

*if you want to add a touch of art to your like they certainly offer something that will make your bike stand apart.*

*Footpegs, Kickstands, Gas Caps, Mirrors but also jewelry; ear rings, belt buckles and an incredible selection of zipper pulls to give your jackets, hoodies and other zipper clothes and bags this touch of art to make these outstanding.*

*If you want your like to be connected to a world of wonders look no further !*







**Kickstands for Harleys & Customs,  
Foot Pegs, Gas Caps, Mirrors and Zipper Pulls.**  
Designer of the Eagle Talon Kickstand and the Salute Skeleton Kickstand.

All Kickstands Are Cast in 17-4 Stainless Steel, Heat Treated, Hardened, And Polished To A Mirror Finish.

Ask for  
your application



Talon Kickstand

Mumblypeg Kickstand

Miss Kitty Rose Kickstand



Skull & Bones Kickstand

Venom Kickstand

Joker Kickstand

Iron Cross Kickstand



Salute Kickstand

Gator Kickstand

Wolfs Paw Kickstand



Eagle Head Kickstand

Crown & Sceptor Kickstand

## Foot Pegs

All Foot Pegs are Cast in Stainless Steel and are Highly Polished. They are Compatible with any 1/2" clevis style female mount, and may be mounted as Highway Pegs, Main Pegs, or Passenger Pegs.



Coffin Pegs



Original Salute Pegs



Crown & Sceptor Pegs



Gator Pegs



Ja Pegs



Flame Pegs



Rose Pegs



Salute Pegs



Skull Pegs



Talon Pegs



Venom Pegs



Woman Pegs



Web Pegs



Wing Pegs



## Gas Caps

GAS CAPS ARE VENTED AND AVAILABLE WITH LEFT AND RIGHT HAND THREADS. ALL GAS CAPS FIT HD STYLE TANKS 1997 AND NEWER.



Eagle Gas Cap Boar Gas Cap Spider Gas Cap Wolf Gas Cap Gator Gas Cap Venom Gas Cap  
Bikini Top Gas Cap Thong Gas Cap Rose Gas Cap Skull & Flame Gas Cap Flame Gas Cap Woman Gas Cap

## Kickstand Covers

Polished Stainless Steel. Fits over all kickstands (US and Metric) and/or any tube with diameter between 3/8" and 3/4" and 8" worth of straight length via hose clamp.



Eagle Wing Cover Flag Cover Flames Cover Lounging Cover  
Salute Cover Skeleton Cover Talon Cover Woman Cover



## Mirrors



## Statue

**IMAGE MOTORCYCLE PRODUCTS**  
KICKSTANDS, KICKSTAND COVERS, GAS CAPS, FOOT PEGS, MIRRORS, LEATHER BAGS, AND MUCH MORE.  
**AVAILABLE HERE**  
ASK YOUR DEALER FOR MORE INFORMATION

**Kickstand Covers**  
IMAGE MOTORCYCLE KICKSTAND COVERS ARE CAST IN AEROSPACE QUALITY STEEL.  
FITS OVER ANY KICKSTAND (US & METRIC) OR ANY 3/8" TO 3/4" DIAMETER WITH 8" OF STRAIGHT LENGTH VIA HOSE CLAMP.  
Image Marine

**Custom Hardware**  
IMAGE MOTORCYCLE'S HIGH QUALITY ZIPPER PULLS ARE CREATED WITH THE ATTENTION TO DETAIL WE PRIDE OURSELVES ON.  
SMALL SIZE IS 2" TO 2.5".  
LARGE SIZE IS 3" TO 3.5".  
CYS - CATCHES AS A ZIPPER PULL.  
PENDANTS REMAIN!  
\$10 SMALL \$12.50 LARGE  
Looks great as a pendant





MANUFACTURING  
U.S.A.



*Kraft/Tech, Inc. was founded in 1990 by Javier Mendoza as a polishing and fabrication company, specializing in products for the motorcycle industry. Mr. Mendoza's background as a machinist and a tool and die maker was the foundation for Kraft/Tech to build aftermarket motorcycle parts. With his professionalism, knowledge, passion and over 35 years of experience in the motorcycle industry, Mr. Mendoza has led Kraft/Tech to be one of the most successful manufacturers of top quality, affordable motorcycles parts, in volume, with short delivery times.*

KRAFT/TEC



124

125

We are dedicated to creating the highest quality aftermarket parts in the USA by combining state-of-the-art equipment, only the best materials and up-to-date management techniques with time-honored traditions of quality workmanship and attention to your needs.

Our product line includes Frames, Gas Tanks, Oil Tanks, Forward Controls, Fenders, Struts, Exhaust, Kickstands, Handlebars and other chrome plated parts. We base our professionalism on the principles of old world craftsmanship and customer service.

Our management team has over 30 years of combined motorcycle experience providing excellent customer service.

We occupy over 42,000 sq. feet of space that houses our welding shop, machine shop, bending operations, warehouse and polishing facilities offering stock on-hand every single day.

We ask you to sit down and enjoy the ride through our enormous selection of top quality motorcycle parts.

## RIGID FRAMES FOR TWIN CAM-B MOTORS 1-1/2" MEGA-TUBE w/HIDDEN AXLE

This line of double down tube frames demonstrates KRAFT/TECH's commitment to quality & affordability without compromise.

- \* Frames for 300/330 tires... 1-3/4" backbone, 1-1/2" thereafter, all DOM steel tubing, mandrel bent
- \* Frames come with 38° or 40° neck rake angles, with front leg stretches of 2", 4", or 8"
- \* These frames accept 2000-up Twin Cam B-Motors
- \* Engineered with a super-strong upper frame design with integral neck webbing that offers unparalleled strength with pleasing aesthetics
- \* These Rigid beauties are delivered complete with billet hidden axle rear section
- \* Rear axle carriers are available in 2 styles: Dagger and Curved Dagger. Axle Cover set included.
- \* Will accept our great-looking oil tanks and of course, our one-piece round top fenders.
- \* Axles are 1" in diameter
- \* Frames accept any 5 or 6-speed Right Side Drive Twin Cam B-style transmission together with 1-1/2" belt on 300 width tires or chain on 330 width tires



2 swingarm styles to choose from



DAGGER



CURVED DAGGER

## 88B RIGID FRAMES FOR 300 OR 330 TIRES w/CHAIN

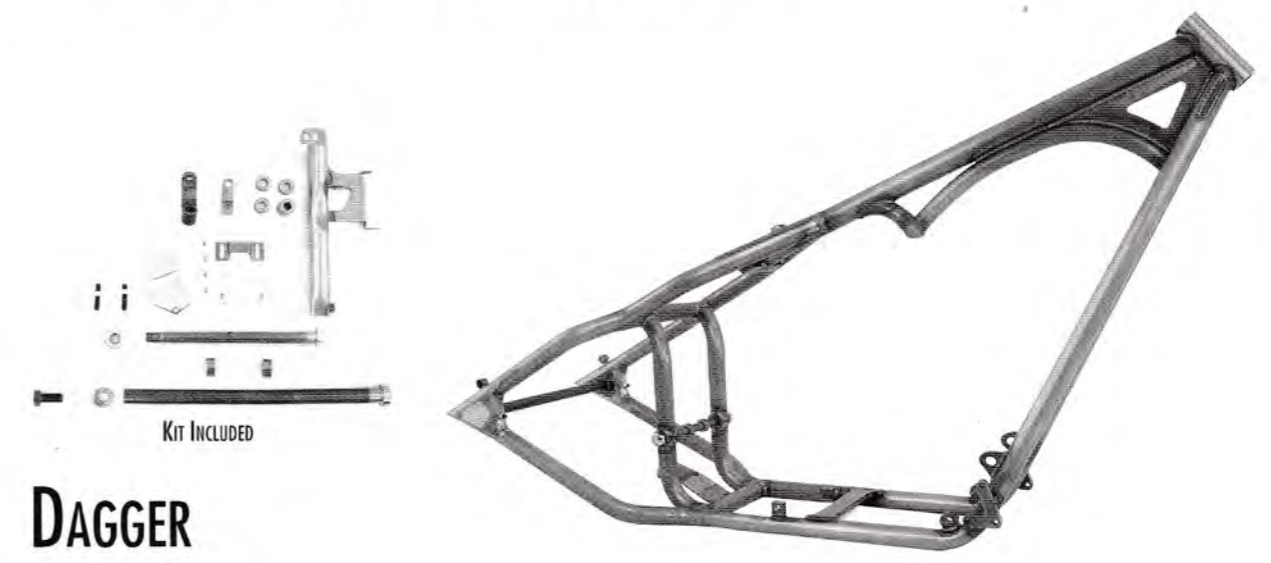

### DAGGER

PART #	STYLE	TIRE WIDTH	TUBING	RAKE	UP STRETCH	BACK BONE STR.	BACK BONE
K19572	88B Rigid	300/330	1-1/2"	38°	2"	5"	1-3/4"
K19575	88B Rigid	300/330	1-1/2"	38°	4"	6-1/2"	1-3/4"
K19578	88B Rigid	300/330	1-1/2"	38°	8"	8-1/2"	1-3/4"
K19581	88B Rigid	300/330	1-1/2"	40°	2"	5"	1-3/4"
K19584	88B Rigid	300/330	1-1/2"	40°	4"	6-1/2"	1-3/4"
K19587	88B Rigid	300/330	1-1/2"	40°	8"	8-1/2"	1-3/4"

**NEW**



### CURVED DAGGER

PART #	STYLE	TIRE WIDTH	TUBING	RAKE	UP STRETCH	BACK BONE STR.	BACK BONE
K19573	88B Rigid	300/330	1-1/2"	38°	2"	5"	1-3/4"
K19576	88B Rigid	300/330	1-1/2"	38°	4"	6-1/2"	1-3/4"
K19579	88B Rigid	300/330	1-1/2"	38°	8"	8-1/2"	1-3/4"
K19582	88B Rigid	300/330	1-1/2"	40°	2"	5"	1-3/4"
K19585	88B Rigid	300/330	1-1/2"	40°	4"	6-1/2"	1-3/4"
K19588	88B Rigid	300/330	1-1/2"	40°	8"	8-1/2"	1-3/4"



### WIDE ROUND TOP STRUTLESS FENDERS FOR 280, 300 & 330 WIDTH TIRES

FOR 280, 300 & 330 TIRE SOFTAIL-STYLE FRAMES

- \* These self supporting 14 gauge steel beauties are, without a doubt, the cure-all for every custom builder
- \* Fender mounting is fast...prep for painting is minimal
- \* Fenders feature welded-in dual wiring tubes and built-in electrical boxes



**NEW**

#### FOR EVO SOFTAIL-STYLE FRAMES

- K40100** 12-1/2" WIDE ROUND TOP STRUTLESS FENDER FOR 280 TIRE EVO STYLE FRAMES
- K40102** 13-1/2" WIDE ROUND TOP STRUTLESS FENDER FOR 300 TIRE EVO STYLE FRAMES
- K40104** 14-1/4" WIDE ROUND TOP STRUTLESS FENDER FOR 330 TIRE EVO STYLE FRAMES

#### FOR TWIN CAM 88B STYLE FRAMES

- K40101** 12-1/2" WIDE ROUND TOP STRUTLESS FENDER FOR 280 TIRE TC 88B STYLE FRAMES
- K40103** 13-1/2" WIDE ROUND TOP STRUTLESS FENDER FOR 300 TIRE TC 88B STYLE FRAMES



### ONE PIECE CUSTOM GAS TANKS

SCREW-IN TYPE GAS CAP BUNG



- K91019**  
Stretched Custom Gas Tank  
Fits custom applications, uses screw in gas cap (not included). Holds approximately 4 gallons.
- |                 |        |
|-----------------|--------|
| Overall length: | 23.25" |
| Tunnel length:  | 23.25" |
| Tunnel width:   | 2.00"  |
| Overall width:  | 13.50" |
| Height:         | 8.86"  |

### ONE PIECE CUSTOM GAS TANKS

POP-UP STYLE GAS CAP BUNG

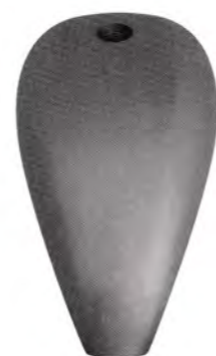

- K91020**  
Stretched Custom Gas Tank  
Fits custom applications, uses pop-up style gas cap (not included).
- |                 |        |
|-----------------|--------|
| Overall length: | 23.25" |
| Tunnel length:  | 23.25" |
| Tunnel width:   | 2.00"  |
| Overall width:  | 13.50" |
| Height:         | 8.86"  |

### FENDERS / STRUTLESS FOR 180 & 230/240 SOFTAIL-STYLE FRAMES

- \* These self-supporting 14 gauge steel beauties are, without a doubt, the cure-all for every custom builder
- \* Fender mounting is fast...prep for painting is minimal
- \* Fenders feature welded-in dual wiring tubes and built in electrical boxes
- \* Available in 9" & 11" wide versions for Softail-style Evolution frames as well as Softail-style Twin Cam 88B frames



#### FOR EVO SOFTAIL-STYLE FRAMES

- K40040** FENDER/STRUTLESS/ROUND TOP... 9" WIDE FOR 180 TIRE SOFTAIL STYLE FRAMES
- K40041** FENDER/STRUTLESS/ROUND TOP... 11" WIDE FOR 230/240 TIRE SOFTAIL STYLE FRAMES



#### FOR TWIN CAM 88B STYLE FRAMES

- K40044** FENDER/STRUTLESS/ROUND TOP... 9" WIDE FOR 180 TIRE SOFTAIL STYLE TC-88B FRAMES
- K40043** FENDER/STRUTLESS/ROUND TOP... 11" WIDE FOR 230/240 TIRE SOFTAIL STYLE TC-88B FRAMES

### FAT BOB FENDER

#### FOR SOFTAIL MODELS 1984 TO PRESENT AND CUSTOM APPLICATIONS

This steel rear fender was designed not to split, it's made from one piece in 0.060" (16 gauge) steel which has been phosphate etched to help prevent corrosion and to give a good base for primers to adhere. The fender is 9" wide, has a more rounded profile across the top to match with today's lower profile tires, a rolled edge along the sides to give more stylish look and an ignition module mounting position already set in. Will accommodate big wheel conversions with tires up to 200 wide.



- K40079** FENDER... 9" WIDE FOR SOFTAIL MODELS 1984 TO PRESENT AND CUSTOM APPLICATIONS



### ROUND TOP FRONT FENDERS / FOR 21" WHEELS

- \* These heavy duty 14 gauge steel fenders are the ideal match for today's 21" tires
- \* They are manufactured by a deep-draw process, resulting in a single cohesive structure that's molecularly sound and able to take the abuse of the hard-riding American biker

### SHORT FRONT FENDERS

- K40080** FENDER/FRONT/SHORT... FOR 21" WHEELS / 4.75" WIDE / UN-DRILLED
- K40081** FENDER/FRONT/SHORT... FOR 21" WHEELS / 4.75" WIDE / DRILLED (SHOWN)
- K40088** FENDER/FRONT/SHORT... FOR 21" WHEELS / 5.50" WIDE / UN-DRILLED
- K40089** FENDER/FRONT/SHORT... FOR 21" WHEELS / 5.50" WIDE / DRILLED (SHOWN)



### BLANK FRONT FENDERS

- K40092** FENDER/FRONT/BLANK... FOR 21" WHEELS / 4.25" WIDE / UN-TRIMMED
- K40082** FENDER/FRONT/BLANK... FOR 21" WHEELS / 4.75" WIDE / UN-TRIMMED
- K40093** FENDER/FRONT/BLANK... FOR 21" WHEELS / 5.50" WIDE / UN-TRIMMED

### LONG FRONT FENDERS

- K40090** FENDER/FRONT/LONG / FOR 21" WHEELS / 4.25" WIDE (STRETCHED)
- K40083** FENDER/FRONT/LONG / FOR 21" WHEELS / 4.75" WIDE (TRIMMED)
- K40091** FENDER/FRONT/LONG / FOR 21" WHEELS / 5.50" WIDE (STRETCHED)



#### CUSTOM CLAW FRONT FENDER

- K40086** FENDER/FRONT/CUSTOM CLAW FOR 21" WHEELS / 4.25" WIDE
- K40087** FENDER/FRONT/CUSTOM CLAW FOR 21" WHEELS / 5.50" WIDE



### STRETCHED FRONT FENDER w/SQUARE-CUT BOTTOM

- K40094** FENDER/FRONT/STRETCHED... FOR 21" WHEELS 4.25" WIDE / SQUARE CUT-BOTTOM
- K40084** FENDER/FRONT/STRETCHED... FOR 21" WHEELS 4.75" WIDE / SQUARE CUT-BOTTOM
- K40095** FENDER/FRONT/STRETCHED... FOR 21" WHEELS 5.50" WIDE / SQUARE CUT-BOTTOM



**K40081**



**K40083**

### OIL TANKS FOR SOFTAIL-STYLE AND RIGID WIDE TIRE FRAMES

CUSTOM HORSESHOE-STYLE FOR 300 TIRE FRAMES

- \* Available for our Softail-style and Rigid 280/300 width tire frames
- \* 3 quart capacity, center fill
- \* Accepts Softail-Style batteries
- \* Better circulation and cooling provided by dumping return oil to the far side of the tank
- \* NPT threaded (1/8" pipe) fittings
- \* Top mounted using our new exclusive grommet mounting system for a clean custom look
- \* Installation grommets available with purchase



**K90077**  
STANDARD

**K90082**  
CUSTOM FIT

- K90077** OIL TANK / WINGED HORSESHOE 3QT. CENTER FILL / RAW FOR SOFTAIL-STYLE AND RIGID 300-330 TIRE RSD FRAMES
- K90078** OIL TANK / WINGED HORSESHOE 3QT. CENTER FILL / CHROME FOR SOFTAIL-STYLE AND RIGID 300-330 TIRE RSD FRAMES
- K90079** OIL TANK / WINGED HORSESHOE 3QT. CENTER FILL / RAW FOR SOFTAIL-STYLE AND RIGID 240-250 TIRE RSD FRAMES
- K90082** CUSTOM OIL TANK / WINGED HORSESHOE 3QT. CENTER FILL / RAW THREADED FOR SOFTAIL-STYLE FRAMES 300-330 TIRE RSD



128



129



# KUSTOM TECH

QUALITY MOTORCYCLE PARTS



# KUSTOM TECH

QUALITY MOTORCYCLE PARTS

*Kustom Tech ... based near Firenze in Italy constructs and builds the coolest stuff and parts for your constructions, transformations !*

*Most of the parts are inspired from the 1930's with clean and streamlined design.*

*From the Hand to the Foot ... a lot of part with details for a clean look !*

*high quality workmanship with classic and compact design*

*The absolutely perfect choice for any project !*



**All that you need to build your choppers with Fine Art Parts from Italy !**  
 Products manufactured and designed in Italy with high quality materials.  
 Here's some of the parts that are proposed to build your projects ...  
 Just have a look on this dress up kit for your S&S carb !  
 For all the categories ... there's some other design available !  
 Just check on his website or ask us !



**VINTAGE GRIPS FOR INTERNAL THROTTLE**  
 Machined from billet aluminum and billet brass, Vintage style grips fit 1" handlebar. Fit with our internal throttle housing Partn° KT/04-005, both left grip and right grip come with 1" internal diam  
 Different finishes available

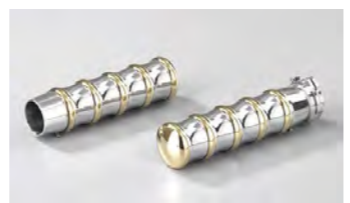

**VINTAGE GRIPS FOR EXTERNAL THROTTLE**  
 Machined from billet aluminum and billet brass, Vintage style grips fit 1" handlebar. Fit with our external trottle housing Deluxe Line, or with all HD style external throttle housing. Different finishes available



**KUSTOM GRIPS WITH WHITE FLANGE**  
 These handlebar Kustom Grips are made in soft and durable rubber, with a removable white plastic end flange. Available in 5 different colors: blue, red, grey, black and green. The left side grip fits all 1" (25,4mm) handlebars, the right side grip fits stock HD or similar 1-1/8" (28,6mm) outside diameter handlebar controls.



**RETRO LINE INVERTED CONTROL**  
 From all forged brass construction, RETRO line inverted hand controls, will give a very nostalgic look to all custom projects. Fit only 1" handlebar with internal diameter 21,5mm, fit in right side for brake, and left side for clutch. Available in different finish, polish brass, satin brass, chrome, satin chrome and raw. About brake and clutch cable, require to build custom cable. (Sold each not pair)



KU/20-652  
Raw Classic



KU/20-650  
Polish Classic



KU/20-651  
Satin Classic



**CLASSIC LINE CLUTCH LEVER ASSEMBLY**

From forged aluminum construction, CLASSIC line cable control matches perfectly our CLASSIC brake master cylinder. Available for clutch and brake side, it fits all 1" handlebars. Both clutch and brake lever assemblies come with 2 cable pins for early and late style cables. The brake lever assemblies work perfectly with mechanical drum brakes, with our wire master cylinder and in many custom applications. Available in 4 different finishes, polish, satin, raw and Black. Note: the brass cable register is sold separately.

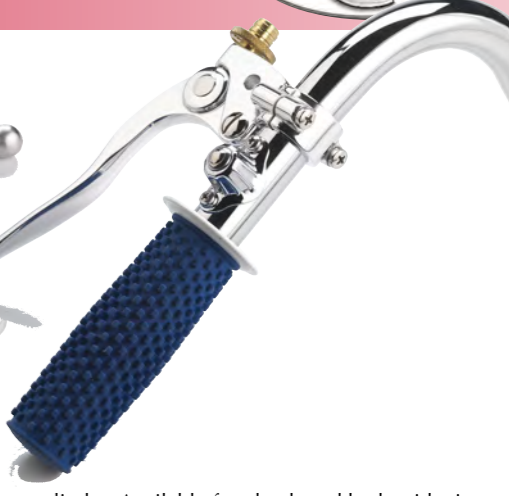

KU/20-600  
Polish Classic 12mm



KU/05-106  
Satin Classic 12mm



KU/20-602  
Raw Classic 12mm



KU/04-021  
Satin Alu



KU/04-022  
Raw Alu



KU/04-020  
Polish Alu



KU/04-010  
Brass Polish

**CLASSIC BRAKE MASTER CYLINDER 12mm or 14mm**  
 From forged aluminum construction, with compact size, finned cover and smooth shape lever, it will give a very retro style look to all handlebar projects. It fits all 1" handlebars, available i 4 different finishes, polish, satin, raw and black. Available with 12mm and 14mm bore, perfectly matches our CLASSIC line clutch lever assembly.

**DELUXE EXTERNAL THROTTLE BRASS OR ALU**

Built in forged aluminum or in forged brass, this external throttle housing works with 1 cable, it's available for 1" (25,4mm) handlebars and 7/8". The aluminum throttle housing, Brass come in 4 finishes: polish, satin, raw and finish. Alum come in 4 finishes: polish, satin, raw and black. Perfectly matching our DELUXE handlebar controls and ideal for more retro-style handlebar projects.



KU/05-106  
Satin Chrome

KU/05-105  
Chrome

KU/05-101  
Brass Satin

KU/05-100  
Brass polish

KU/05-102  
Brass Raw



**DELUXE RISERS**

From forged brass construction, Deluxe risers come in 5 different finishes. They fit all 1" handlebars and come with 1/2"X13 mounting bolts, 2,5" rise and 1" pullback. Designed to match perfectly our Deluxe line handlebar controls or for many others 1" handlebar projects. Also exist for 7/8" handlebars.

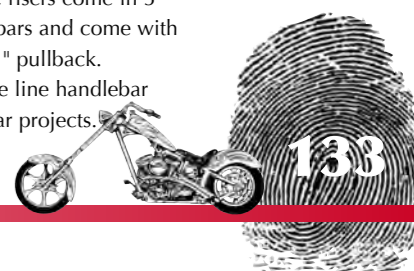



# KUSTOM TECH



**DELUXE LINE 1 or 2 BUTTON SWITCH HOUSING**  
 From forged brass construction, 2 buttons Deluxe switch housing comes in 5 different finishes, and can be used for many applications. Designed with external fins to match perfectly our Deluxe and Classic line handlebar control, or all early style handlebar projects.



**PETCOCK FOR S&S Super E/G or Super B or Inline**  
 Machined from billet brass with chrome finish or polish finish, a very clean look, will give the look without petcock, fit directly in the bottom of S&S Super E/G carburetor, or will give the impression you have no petcock, fit in all fuel line with 5/16" internal diameter hose.  
 (NOTE: This petcock has not reserve)



**VINTAGE LINE FORWARD CONTROL IN ALUMINUM AND BRASS (polish)**  
 Machined from billet aluminium, pegs and shifter pegs are designed with aluminium and brass rings giving it that vintage look, matching perfectly with passenger pegs, vintage grips as well as our alu & brass parts line.. It fits all FXST and FL model from 1986 to 1999. Requires the purchase of our weld-on kickstand, it comes with complete aluminium adjustment shifter rod, hardware and banjo fitting.



**KU/40-060**  
 Forward control kit



**WIRE OPERATOR MASTER CYLINDER WITH RESERVOIR**  
 Machined from billet aluminium with a small external design for an easy hidden placement under seat, tank or other place. 14mm bore size, this master cylinder matches perfectly our weld-on wire hand control and it's suitable for more custom application.

**KU/40-180 Polish**  
**KU/40-182 Black**



**KU/40-080 Polish**  
**KU/40-082 Black**

**WIRE OPERATOR MASTER CYLINDER**  
 Machined from billet aluminium with a small design, 14mm bore size, your handlebar will have no master cylinder for a real clean look. It works for clutch or brake application, it requires our wire handlebar controls. Available in polished or black finish.

## FRONT MINI DRUM BRAKE

Mini front drum brake is build from a cast iron, material with a high friction coefficient, works well even with small diameter.  
 In the central of the drum there are fins, that in addition to giving a nostalgic look guarantee a good cooling.  
 The inner of the drum is machined to cnc to guarantee a perfect matching with the shoes.  
 The two side cover are made from aluminum, on the left cover there are the shoes (5"-1/8" Diameter)  
 The drilling of spokes is made to be assembled with 40 spokes rims, available all in chrome finish.



**KU/03-600**  
 Chrome



## HYDRAULIC REAR DRUM BRAKE

This hydraulic drum will give an absolutely radical and a retro style to your bike, it was designed taking inspiration from Rodder drums of the 50s.  
 The central part is built from cast iron, material with a high degree of friction, it comes with a 51 teeth sprocket within the front plate.  
 Machined from solid aluminum, the brake shoes are anchored (Type HD from 1958 to '62) and activated by hydraulic cylinders, on the back brass fins are screwed around the drum, and besides giving a very special look they provide an excellent cooling. (When mounted on frames with the original width of the tail, you may want to mount one of our wheel hubs because it's more narrow).  
 The drum is provided with a perforated aluminum anchor rod which is to be anchored to the frame through a special support, that's also provided.  
 The drum is available in 2 versions, all chromed including fins, or entirely plated with polished brass fins.



## 11" RIBBED RIGID STRUTS

Kustom Tech Rigid Ribbed Struts build in high quality steel, CNC machined with top and bottom eye TIG welded.  
 Measure 11" from center to center eye mount, build with top and bottom Silent Block.  
 Fit on HD models with 1/2" shock mounting studs.  
 Kustom Tech Ribbed Rigid Struts lower the bike below stock, after assembling check the clearance between rear fender and tire.  
 All in chrome finish.



**KU/60-001**



## 11" SPRING STRUTS

Kustom Tech spring struts build in high quality steel, with top and bottom eye TIG welded.  
 Chrome quality spring provide to give more confort then the rigid strut.  
 Measure 11" from center to center eye mount.  
 Build with top and bottom Silent Block, fit on HD models with 1/2" shock mounting stud.  
 Kustom Tech Spring Struts can be mounted in both position, with top spring or with bottom spring.  
 Kustom Tech Spring Struts lower the bike below stock, after assembling check the clearance between rear fender and tire.  
 Only for custom application.



**KU/60-005**







*La Rosa Design specializes in designing and crafting the best quality aftermarket leather products for Harley-Davidson motorcycles. La Rosa Design is the motorcycle part sector which separated from SL Factory in 2008. Established by Don La Rosa in 1972, SL Factory manufactured and distributed fender trims for several major auto makers from its factories in Thailand, Mexico and the U.S. Now, the heart of Don's business is solely in the motorcycle accessories sector. With increasing demand for La Rosa products from customers as well as wholesalers, Don started to focus on developing quality saddle bags and accessories for their motorcycles. His experience in the motorcycle industry coupled with his passion for Harley and crafting means customers get the best accessories on the market.*





# LA ROSA DESIGN



### Quality products by La Rosa Design

Products manufactured and designed at La Rosa include leather bags, exhaust heat shields, and apparel.

La Rosa also manufactures leather seats with mounting hardware for H-D Chopper Bobber custom bikes, Sportster, Softail, Dyna and Touring bikes.

All materials used to build a La Rosa bag or seat are chosen and tested by our sourcing and production team to make sure the products are value-adding pieces on our customers' bikes. Everything La Rosa makes is 100% manufactured here in the USA. The core of La Rosa centers around designing and manufacturing the most unique and innovative products on the market. La Rosa's goal is to provide more comfort, practicality and style with our products to make riding a more unique, personal and enjoyable experience. We hope you're as excited to try them out as we are to make them!

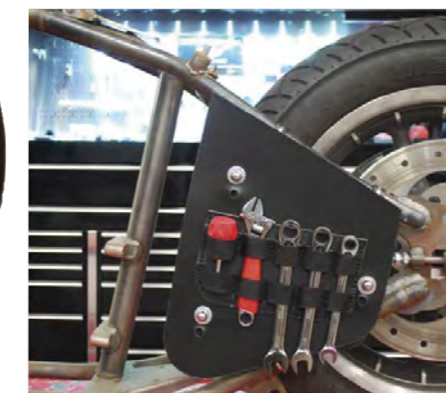
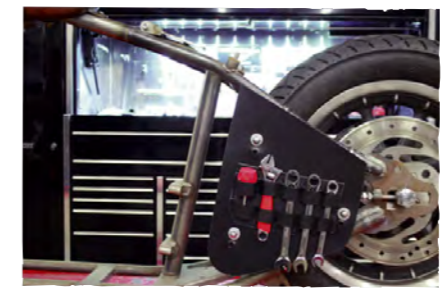

All materials used to build a La Rosa bag or seat are chosen and tested by our sourcing and production team to make sure the products are value-adding pieces on our customers' bikes. Everything La Rosa makes is 100% manufactured here in the USA.

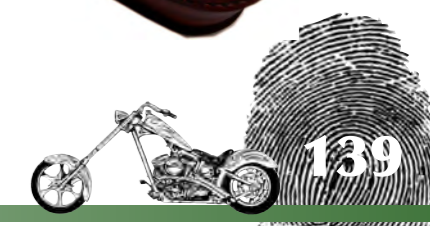



# LA ROSA DESIGN



The core of La Rosa centers around designing and manufacturing the most unique and innovative products on the market. La Rosa's goal is to provide more comfort, practicality and style with our products to make riding a more unique, personal and enjoyable experience. We hope you're as excited to try them out as we are to make them!



Products manufactured and designed at La Rosa include leather bags, exhaust heat shields and apparel. La Rosa also manufactures leather seats with mounting hardwares for H-D Chopper, Bobber, custom bikes, Sportster, Softail, Dyna and Touring bikes.





*If you're into custom likes or custom lifestyles, you probably already know about Led Sled Customs out of Dayton, Ohio. But, if you're into Sportsters and I mean really into Sportsters, you definitely know about Led Sled. They probably are the motorcycle equivalent of Sportsters R Us if there ever was one and that's a good thing. Sportsters, like any Harley, can be as screaming cool or as sh\*tty sh\*tass as you can make them. It's all up to you — your imagination, your talent, your budget, your dream. And that could include the nice fellows at Led Sled Customs, liked owner Patrick "Pat" Patterson who just might cater to your every whim as long as it doesn't disgust them. Hey, just because Led Sled loves Sportys doesn't mean they have to love every single one.*

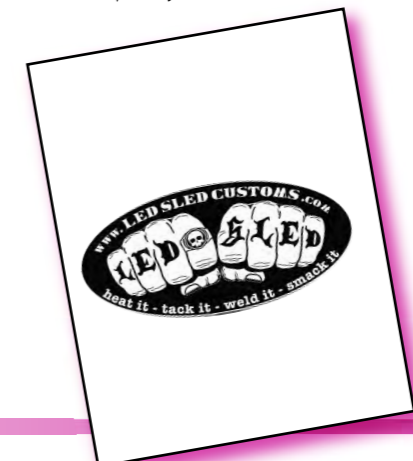



### Hardtail kit ... or complete Hardtail kit

Make the choice of your year and size of tire needed and we take care of all!  
Choose and Hardtail kit or a Complete Hardtail Kit  
From stock rear tire to 240-250 !

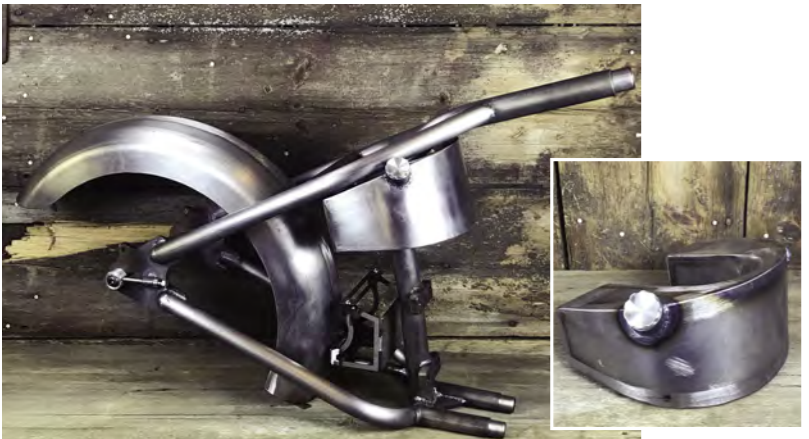

### COMPLETE HARDTAIL KIT - IRONHEAD TO 2018

GET THE NEW HORSESHOE OIL TANK WITH THIS KIT!  
The complete kit includes hardtail, axle and adjusters along with our new horseshoe oil tank and battery box of your choice (both mounted) and a fender of your choice. Please choose 2" or 4" stretch and rear tire size needed- stock, 180/200, or 240/250.  
Need a brake tab? Add it to your order!  
Need a new seat? Add our seat pan kit to your order



### COMPLETE HARDTAIL KIT- 2004 AND UP

The complete kit includes hardtail, axle and adjusters along with an oil tank and battery box of your choice (both mounted) and a fender of your choice. Please choose 2" or 4" stretch and rear tire size needed- stock, 180/200, or 240/250.



### COMPLETE HARDTAIL KIT- 2004 AND UP

The Complete Hardtail Kit for the 2004 comes with your choice battery box, oil bag, and fender. We offer a 2" stretch and your choice of rear tire size- stock, 180/200, and 240/250. The kit does require a little more work and some basic skill in leveling and welding, but also includes axle/adjusters and the mounts for the oil bag/battery box.  
Going to a hardtail will require changing to a chain- so ask for our belt to chain conversion kit!



### COMPLETE HARDTAIL KIT- 2004 AND UP

Now offering our hardtails in a dropseat design for Sportsters up to 2003. The dropseat lowers your seat position 4 inches... just enough to look good but not ridiculous.. This kit is available with a 4" stretch and for the stock, 180/200 and 240/250 rear tire. A complete kit is also available for this hardtail. This kit requires belt to chain conversion, no worry we offer a kit for it !  
For 2004 and up Sportsters, we can build you a dropseat frame!



144

### Fender Struts kit

This strut kit is designed to cut and weld to the length you want... our struts are made with set screws that will hold the hardware in place after you tighten it... no more bolts coming loose.



### Contour Fender

All fenders are made in-house using 13 gauge steel. The Contour fender is a completely smooth top fender. We can spin your fender in almost any size to match the tire diameter and radius perfect.. for best results call the shop to order and let us know the size and width you need.  
\*\*We need the following measurements when ordering:  
- height of tire from ground to top of tread (in inches)  
- width you want the fender (in inches)



### Flat Top Rear Fender

The Flat Top fender has roughly a 2 inch raised flat section down center of fender. We can spin your fender in almost any size to match the tire diam and radius perfect for best results call us to order and let us know the size and width you need.  
\*\*We need the following measurements when ordering:  
- height of tire from ground to top of tread (in inches)  
- width you want the fender (in inches)



### Mohawk Rear Fender

The Mohawk fender has a nice raised spike down center of fender. We can spin your fender in almost any size to match the tire diameter and radius perfect.. for best results call the shop to order and let us know the size and width you need.  
\*\*We need the following measurements when ordering:  
- height of tire from ground to top of tread (in inches)  
- width you want the fender (in inches)

### Fenders

The three designs available in all these widths:  
26 inch Dia - 6 inch (Stock Style Tires)  
28 inch Dia - 6 inch (Vintage Tires)  
27 1/2 inch Dia - 7 inch , 8 inch, 8 1/4 inch, 8 1/2 inch, 9 inch  
150 - 200 Size Tires



### Wheel Covers For 16" Sporty MAG Wheels



### Ledsled Invader Wheels

available in 16", 21" and 23"  
**Finishes :**  
Raw,  
Gloss Black  
Flat Black  
Chrome



145



# LEDSLED CUSTOM

## Other kool stuff by Ledsled custom ...

Jockey shift kit, kicker kit, floorboard kit, battery boxes,

### GEAR JAMMER JOCKEY SHIFT KIT

This Jockey Shift kit will work on 1986 to current model Sportsters running forward controls. It comes raw and with everything you need. It will require slight modifications to your clutch cable and shifter peg. Please be sure to choose the correct kit when ordering... 4 speed, 5 speed, or 2004 & up. Black powdercoat (gloss or flat)



### KICKER KIT

- Want to add some cool factor to your start button bike? Kick it. Install our Kicker on your bike today. Best part? We offer a LIFETIME WARRANTY on the Kicker and FREE SHIPPING.
- Kit includes: ANDREWS main shaft, cover, kicker kit, and arm. (Pedal purchased separately)
  - Main shaft works with BAKER 6-Speed transmission
  - Kit fits ONLY 1991-2003 5 speed Sportsters.
  - Kit works with stock pipes and also LSC short & long shots.
  - Kit is bolt on, but you will have to change main shaft in your transmission.
  - If you run mid-controls, you will need to fab something to maintain them.
  - You will have to relocate master cylinder.
  - Comes in raw aluminum finish.
  - Yes you will keep your starter.



### SPORTSTER FLOORBOARDS- 2004 and up

These floorboards fit 2004 to current model Sportsters and are designed to bolt up to your stock forward controls. All hardware is included they have Led Sled special design rubber mats. The floorboards are offered raw, powdercoat gloss/flat black, or polished. Please confirm if you own a 48 Model



### SPEEDHOLE BATTERY BOX

These battery boxes are slick and light- a trimmed down version that fits the smaller battery we typically use on our Sportsters. We suggest the smaller application on all of our Sportster kits so you can place the battery in front of the rear tire. Battery dimensions: 5 1/4"H x 6"W x 3 1/2"D



### CLASSIC BATTERY BOX

These battery boxes are slick and light- a trimmed down version that fits the smaller battery we typically use on our Sportsters. We suggest the smaller application on all of our Sportster kits so you can place the battery in front of the rear tire. Battery dimensions: 5 1/4"H x 6"W x 3 1/2"D



OIL TANK Derby

OIL TANK Indent

OIL TANK Ribbed

OIL TANK Smooth

OIL TANK Spade

### OIL TANK

Built in-house our LedSled custom oil tanks hold 3 quarts and measure 10" x 5" All tanks are raw steel. Don't forget...  
- Brackets  
- Fittings



OIL TANK Fitting Brass

OIL TANK Fitting

OIL TANK Brackets

### MID SPRINGER

The MID springer allows room for a brake set-up but gives your bike a tighter look than our wide option. So if you just need that size in-between narrow and wide- here you go! These will fit ANY bike- not just Sportys. They are homemade on request. They come in raw or flat/gloss black powdercoat. Chrome is available for an extra charge. Springers fit all years. Neck is 1". Possibility on ask to make a 7/8" neck. We need the following measurement to ensure a good fit- length from the top of the bottom triple tree to current axle (in inches). Please provide this length and the bike year Available in Raw, Flat Black or Gloss Black !



### SPRINGER FRONT BRAKE

4 piston springer front brake. Direct bolt-on to Led Sled Wide Springers. Offered in RIGHT side BLACK.

### NARROW SPRINGER

The NARROW springer will fit ANY bike- not just Sportys. Please note the hub cannot be wider than 3.75". They are homemade on request. They come in raw or flat/gloss black powdercoat. Chrome is extra. Springers fit all years. Neck is 1". Please call if you need a 7/8" neck. We need the following measurement to ensure a good fit- length from the top of the bottom triple tree to current axle (in inches). Please provide this length and the bike year Available in Raw, Flat Black or Gloss Black !

### WIDE SPRINGER

The Wide springer allows room for a brake set-up These will fit ANY bike- not just Sportys. They are homemade on request. They come in raw or flat/gloss black powdercoat. Chrome is available for an extra charge. Springers fit all years. Neck is 1". Possibility on ask to make a 7/8" neck. We need the following measurement to ensure a good fit- length from the top of the bottom triple tree to current axle (in inches). Please provide this length and the bike year Available in Raw, Flat Black or Gloss Black !

### BELT TO CHAIN CONVERSION KIT- 240/250

Our Belt to Chain Conversion kit is designed to fit 5-speed Sportsters with a 240/250 tire application. Kit comes with our LedSled chain, 240/250 front sprocket, and 48 tooth chrome rear sprocket.

### BELT TO CHAIN CONVERSION KIT- 180/200

Our Belt to Chain Conversion kit is designed to fit 5-speed Sportsters with a 180/200 tire application. Kit comes with our LedSled chain, 180/200 front sprocket, and 48 tooth chrome rear sprocket. We also offer the kit for 4 speed 1986 to 1990 with our custom made offset sprocket.

### BELT TO CHAIN CONVERSION KIT- (STOCK) 130/150

Our Belt to Chain Conversion kit is designed to fit 5-speed Sportsters with a STOCK 130/150 tire application. Kit comes with our LedSled chain, 130/150 front sprocket, spacer, and 48 tooth chrome rear sprocket.

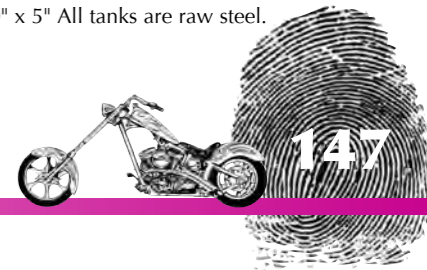

# EXHAUST SYSTEM MCJ



*If your neighborhood and local police are not in for noisy engines but you still want a bit of tone while on open spaces, playing your music without disturbing anyone then Mcj can help with their adjustable sound valve exhaust system.*

*Cable or electronic control allow you to use this system on demand so you can keep quiet when loud pipes do not save lives but make you a bother.*

*Mcj is an Italian brand and as Italy is the country of design they also have a line of high class saddlebags and windshields with a design that you will not find from any other manufacturer.*

*Solo seat kits, headlamp gull and side mount license plate holder come to complete this line with matching style and quality.*

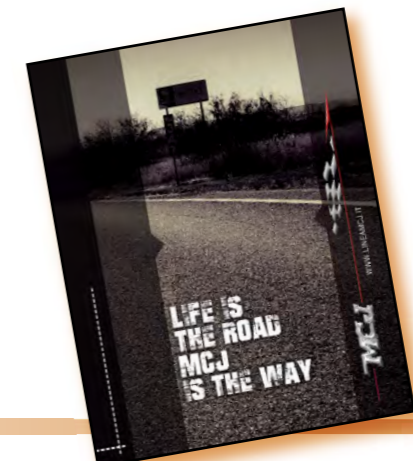

## Sportster

### To get you complete homologated exhaust kit :

You need to order the homologated baffle ... MCJ/A001  
 After your Mufflers in Chrome or Black depending of your model & year  
 Your end caps in Chrome or in Black  
 And your Electronic motor ... if not your kit will be manual with cables



**2 in 2 Royal Chrome Sporty 2004 up** MCJ/2XL-C  
 with Ending MCJ/B081-C  
 Homologation MCJ/A001  
 Electronic motor MCJ/remote2

They are delivered with your choice of end caps  
 (see below) Chrome or Black

### 2 in 2 Royal Cigars Mufflers Sporty 883-1200 Until 2003

MCJ/A001 ... Homologated mufflers  
 MCJ/1XL-C ... Royal Cigar 2 in 2 Chrome  
 MCJ/1XL-B ... Royal Cigar 2 in 2 Black  
 MCJ/remote1 ... Electronic Motor

### Sporty 883-1200 2004-2016

MCJ/A001 ... Homologated mufflers  
 MCJ/2XL-C ... Royal Cigar 2 in 2 Chrome  
 MCJ/2XL-B ... Royal Cigar 2 in 2 Black  
 MCJ/staffa14 ... Bracket for 2014-2016 models  
 MCJ/remote2 ... Electronic Motor

### Sporty 883-1200 2017

MCJ/A001 ... Homologated mufflers  
 MCJ/3XL-C ... Royal Cigar 2 in 2 Chrome  
 MCJ/3XL-B ... Royal Cigar 2 in 2 Black  
 MCJ/cat ... Couple of cat or royal mufflers  
 MCJ/remote31 ... Electronic Motor

### The End Cap Choice for the Royal 2 in 2 Cigars



MCJ/B029-C ... Chrome B029 Ending  
 MCJ/B029-B ...Black B029 Ending



MCJ/B030-C ... Chrome B030 Ending  
 MCJ/B030-B ...Black B030 Ending

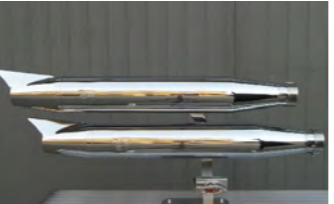

MCJ/B072-C ... Chrome B072 Ending  
 MCJ/B072-B ...Black B072 Ending



MCJ/B073-C ... Chrome B073 Ending  
 MCJ/B073-B ...Black B073 Ending



MCJ/B075-C ... Chrome B075 Ending  
 MCJ/B075-B ...Black B075 Ending

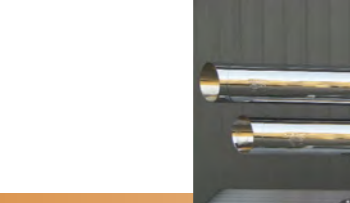

MCJ/B075-C ... Chrome B075 Ending  
 MCJ/B075-B ...Black B075 Ending



**Royal Short Chrome Sporty 04 up** MCJ/2XL-RS-C  
 Homologation MCJ/A001  
 Electronic motor MCJ/remote2

They are delivered with the headpipes and your choice of Heatshields with or without holes

### Royal Short Exhausts Sporty 883-1200 2004-2016

MCJ/A001 ... Homologated mufflers  
 MCJ/2XL-RS-C ... Royal Short Chrome  
 MCJ/2XL-RS-B... Royal Short Black  
 MCJ/remote2 ... Electronic Motor

### Sporty 883-1200 2017

MCJ/A001 ... Homologated mufflers  
 MCJ/3XL-RS-C ... Royal Short Chrome  
 MCJ/3XL-RS-B ... Royal Short Black  
 MCJ/remote31 ... Electronic Motor



**Big Short Black Sporty 04 up** MCJ/2XL-BST-B  
 Homologation MCJ/A001  
 Electronic motor MCJ/remote2

They are delivered with the headpipes, your choice of Heatshields with or without holes and in Slash Cut or Tapered Style

### Big Short Exhausts Sporty 883-1200 2004-2016

MCJ/A001 ... Homologated mufflers  
 MCJ/2XL-BST-C ... BigShort Chrome Tapered  
 MCJ/2XL-BST-B... BigShort Black Tapered  
 MCJ/2XL-BSSC-C ... BigShort Chrome Slash Cut  
 MCJ/2XL-BSSC-B... BigShort Black Slash Cut  
 MCJ/remote2 ... Electronic Motor

### Sporty 883-1200 2017

MCJ/A001 ... Homologated mufflers  
 MCJ/3XL-BST-C ... BigShort Chrome Tapered  
 MCJ/3XL-BST-B... BigShort Black Tapered  
 MCJ/3XL-BSSC-C ... BigShort Chrome Slash Cut  
 MCJ/3XL-BSSC-B... BigShort Black Slash Cut  
 MCJ/remote31 ... Electronic Motor

### Complete 2 in 1 exhaust also exist for Sporty's

Just ask your style for model and years !

## Dyna

### 2 in 2 Royal Cigars Mufflers Dyna Siwtchback 2012-2016

MCJ/A001 ... Homologated mufflers  
 MCJ/1DY-C ... Royal Cigar 2 in 2 Chrome  
 MCJ/1DY-B ... Royal Cigar 2 in 2 Black  
 MCJ/remote3 ... Electronic Motor

### Dyna 1340-1450-1580-1690 until 2016

MCJ/A001 ... Homologated mufflers  
 MCJ/2DY-C ... Royal Cigar 2 in 2 Chrome  
 MCJ/2DY-B ... Royal Cigar 2 in 2 Black  
 MCJ/remote4 ... Electronic Motor

### Dyna Street Bob & Low Rider 2017

MCJ/A001 ... Homologated mufflers  
 MCJ/3DY-C ... Royal Cigar 2 in 2 Chrome  
 MCJ/3DY-B ... Royal Cigar 2 in 2 Black  
 MCJ/cat ... Couple of cat or royal mufflers  
 MCJ/remote32 ... Electronic Motor

### Dyna Low Rider S 2017

MCJ/A001 ... Homologated mufflers  
 MCJ/4DY-C ... Royal Cigar 2 in 2 Chrome  
 MCJ/4DY-B ... Royal Cigar 2 in 2 Black  
 MCJ/cat ... Couple of cat or royal mufflers  
 MCJ/remote33 ... Electronic Motor

### Dyna Fat Bob & Wide Glide 1580-1690 until 2016

MCJ/A001 ... Homologated mufflers  
 MCJ/5DY-C ... Royal Cigar 2 in 2 Chrome  
 MCJ/5DY-B ... Royal Cigar 2 in 2 Black  
 MCJ/remote5 ... Electronic Motor

### Dyna Fat Bob & Wide Glide2017

MCJ/A001 ... Homologated mufflers  
 MCJ/6DY-C ... Royal Cigar 2 in 2 Chrome  
 MCJ/6DY-B ... Royal Cigar 2 in 2 Black  
 MCJ/cat ... Couple of cat or royal mufflers  
 MCJ/remote34 ... Electronic Motor



2 in 1 System available for Sporty's, Dyna's, Softail's

### Royal Short Exhausts Dyna 1340-1450-1580-1690 until 2016

MCJ/A001 ... Homologated mufflers  
 MCJ/2DY-RS-C ... Royal Short Chrome  
 MCJ/2DY-RS-B... Royal Short Black  
 MCJ/remote4 ... Electronic Motor

### Dyna Street Bob & Low Rider 2017

MCJ/A001 ... Homologated mufflers  
 MCJ/3DY-RS-C ... Royal Short Chrome  
 MCJ/3DY-RS-B ... Royal Short Black  
 MCJ/remote32 ... Electronic Motor

### Dyna Low Rider S 2017

MCJ/A001 ... Homologated mufflers  
 MCJ/4DY-RS-C ... Royal Short Chrome  
 MCJ/4DY-RS-B ... Royal Short Black  
 MCJ/remote33 ... Electronic Motor

### Dyna Fat Bob & Wide Glide 1580-1690 until 2016

MCJ/A001 ... Homologated mufflers  
 MCJ/5DY-RS-C ... Royal Short Chrome  
 MCJ/5DY-RS-B ... Royal Short Black  
 MCJ/remote5 ... Electronic Motor

### Dyna Fat Bob & Wide Glide2017

MCJ/A001 ... Homologated mufflers  
 MCJ/6DY-RS-C ... Royal Short Chrome  
 MCJ/6DY-RS-B ... Royal Short Black  
 MCJ/cat ... Couple of cat or royal mufflers  
 MCJ/remote34 ... Electronic Motor

### 2 in 1 Royal Megaphone Stainless steel Dyna 1580 MCJ/2DY-MS

Homologation MCJ/A001  
 Electronic motor MCJ/remote4

There 3 different mufflers option, Stainless Steel, Carbon Racing or Racing Polished

### Dyna 1340-1450-1580-1690 until 2016

MCJ/A001 ... Homologated mufflers  
 MCJ/2DY-MS ... 2 in 1 Megaphone Stainless Steel  
 MCJ/2DY-CR ... 2 in 1 Carbon Racing  
 MCJ/2DY-PSR ... 2 in 1 Racing Polished Stain Steel  
 MCJ/remote4 ... Electronic Motor

### Dyna Street Bob & Low Rider 2017

MCJ/A001 ... Homologated mufflers  
 MCJ/3DY-MS ... 2 in 1 Megaphone Stainless Steel  
 MCJ/3DY-CR ... 2 in 1 Carbon Racing  
 MCJ/3DY-PSR ... 2 in 1 Racing Polished Stain Steel  
 MCJ/remote32 ... Electronic Motor

### Dyna Low Rider S 2017

MCJ/A001 ... Homologated mufflers  
 MCJ/4DY-MS ... 2 in 1 Megaphone Stainless Steel  
 MCJ/4DY-CR ... 2 in 1 Carbon Racing  
 MCJ/4DY-PSR ... 2 in 1 Racing Polished Stain Steel  
 MCJ/remote33 ... Electronic Motor

### Dyna Fat Bob & Wide Glide 1580-1690 until 2016

MCJ/A001 ... Homologated mufflers  
 MCJ/5DY-MS ... 2 in 1 Megaphone Stainless Steel  
 MCJ/5DY-CR ... 2 in 1 Carbon Racing  
 MCJ/5DY-PSR ... 2 in 1 Racing Polished Stain Steel  
 MCJ/remote5 ... Electronic Motor

### Dyna Fat Bob & Wide Glide2017

MCJ/A001 ... Homologated mufflers  
 MCJ/6DY-MS ... 2 in 1 Megaphone Stainless Steel  
 MCJ/6DY-CR ... 2 in 1 Carbon Racing  
 MCJ/6DY-PSR ... 2 in 1 Racing Polished Stain Steel  
 MCJ/remote34 ... Electronic Motor



MCJ/B076-C ... Chrome B076 Ending  
 MCJ/B076-B ...Black B076 Ending



MCJ/B077-C ... Chrome B077 Ending  
 MCJ/B077-B ...Black B077 Ending



MCJ/B080-C ... Chrome B080 Ending  
 MCJ/B080-B ...Black B080 Ending



MCJ/B081-C ... Chrome B081 Ending  
 MCJ/B081-B ...Black B081 Ending



MCJ/B078-C ... Chrome B078 Ending  
 MCJ/B078-B ...Black B078 Ending



MCJ/B079-C ... Chrome B078 Ending  
 MCJ/B079-B ...Black B078 Ending

If you did not find your bike application ... just ask us and we give you a quote !

<http://lineamcj.it/en>







# Softail until 2017



**2 in 2 Royal Black Softail Fat Boy 2017**  
MCJ/10SF-B with Ending MCJ/B081-C  
Homologation MCJ/A001  
Electronic motor MCJ/remote37

They are delivered with your choice of end caps (see below) Chrome or Black



**Race Mufflers Black Softail Street Bob 2018**  
MCJ/17SF-B with Ending MCJ/B081-B  
Homologation MCJ/A003  
Electronic motor MCJ/motor18

They are delivered with your choice of end caps (see below) Chrome or Black

# MCJ EXHAUSTS

## Softail 2018

For the 2018 Softails The Race Mufflers could be ordered with this choice of Ending : B073 - B075 - B076 - B080 and B081

### Softail 2018 Street Bob - Low Rider - Slim - Breakout - Fat Boy

- MCJ/A003 ... Homologated mufflers
- MCJ/17SF-C ... Race Mufflers Chrome
- MCJ/17SF-B ... Race Mufflers Black
- MCJ/motor18 ... Electronic Motor

### Softail 2018 Fat Bob

- MCJ/A003 ... Homologated mufflers
- MCJ/18SF-C ... Race Mufflers Chrome
- MCJ/18SF-B ... Race Mufflers Black
- MCJ/motor19 ... Electronic Motor



**Race Mufflers Black Softail Street Bob 2018**  
MCJ/17SF-B with Ending MCJ/B081-B  
Homologation MCJ/A003  
Electronic motor MCJ/motor18

They are delivered with your choice of end caps (see below) Chrome or Black

### 2 in 2 Royal Cigars Mufflers Softail 1340 Until 2008

- MCJ/A001 ... Homologated mufflers
- MCJ/15F-C ... Royal Cigar 2 in 2 Chrome
- MCJ/15F-B ... Royal Cigar 2 in 2 Black
- MCJ/remote6 ... Electronic Motor

### Softail 1450 Night Train Std Heritage Until 2006

- MCJ/A001 ... Homologated mufflers
- MCJ/25F-C ... Royal Cigar 2 in 2 Chrome
- MCJ/25F-B ... Royal Cigar 2 in 2 Black
- MCJ/remote7 ... Electronic Motor

### Softail 1540-1690 Until 2016

- MCJ/A001 ... Homologated mufflers
- MCJ/35F-C ... Royal Cigar 2 in 2 Chrome
- MCJ/35F-B ... Royal Cigar 2 in 2 Black
- MCJ/remote8 ... Electronic Motor

### Softail Heritage Classic 2017

- MCJ/A001 ... Homologated mufflers
- MCJ/45F-C ... Royal Cigar 2 in 2 Chrome
- MCJ/45F-B ... Royal Cigar 2 in 2 Black
- MCJ/cat ... Couple of cat or royal mufflers
- MCJ/remote35 ... Electronic Motor

### 2 in 2 Royal Cigars Mufflers Softail Breakout Until 2016

- MCJ/A001 ... Homologated mufflers
- MCJ/55F-C ... Royal Cigar 2 in 2 Chrome
- MCJ/55F-B ... Royal Cigar 2 in 2 Black
- MCJ/remote9 ... Electronic Motor

### Softail Breakout 2017

- MCJ/A001 ... Homologated mufflers
- MCJ/65F-C ... Royal Cigar 2 in 2 Chrome
- MCJ/65F-B ... Royal Cigar 2 in 2 Black
- MCJ/cat ... Couple of cat or royal mufflers
- MCJ/remote36 ... Electronic Motor

### Softail 1450 Fat Boy Until 2008

- MCJ/A001 ... Homologated mufflers
- MCJ/85F-C ... Royal Cigar 2 in 2 Chrome
- MCJ/85F-B ... Royal Cigar 2 in 2 Black
- MCJ/remote10 ... Electronic Motor

### Softail 1580-1690 Fat Boy Until 2016

- MCJ/A001 ... Homologated mufflers
- MCJ/95F-C ... Royal Cigar 2 in 2 Chrome
- MCJ/95F-B ... Royal Cigar 2 in 2 Black
- MCJ/remote11 ... Electronic Motor

### 2 in 2 Royal Cigars Mufflers Softail Fat Boy 2017

- MCJ/A001 ... Homologated mufflers
- MCJ/10SF-C ... Royal Cigar 2 in 2 Chrome
- MCJ/10SF-B ... Royal Cigar 2 in 2 Black
- MCJ/cat ... Couple of cat or royal mufflers
- MCJ/remote37 ... Electronic Motor

### Softail DeLuxe CrossBone Slim 07-16

- MCJ/A001 ... Homologated mufflers
- MCJ/12SF-C ... Royal Cigar 2 in 2 Chrome
- MCJ/12SF-B ... Royal Cigar 2 in 2 Black
- MCJ/remote13 ... Electronic Motor

### Softail DeLuxe 2017

- MCJ/A001 ... Homologated mufflers
- MCJ/13SF-C ... Royal Cigar 2 in 2 Chrome
- MCJ/13SF-B ... Royal Cigar 2 in 2 Black
- MCJ/cat ... Couple of cat or royal mufflers
- MCJ/remote14 ... Electronic Motor

### Softail Slim 2017 (Not the Slim S)

- MCJ/A001 ... Homologated mufflers
- MCJ/14SF-C ... Royal Cigar 2 in 2 Chrome
- MCJ/14SF-B ... Royal Cigar 2 in 2 Black
- MCJ/cat ... Couple of cat or royal mufflers
- MCJ/remote11 ... Electronic Motor



MCJ/B073-C ... Chrome B073 Ending  
MCJ/B073-B ... Black B073 Ending



MCJ/B075-C ... Chrome B075 Ending  
MCJ/B075-B ... Black B075 Ending



MCJ/B076-C ... Chrome B076 Ending  
MCJ/B076-B ... Black B076 Ending



MCJ/B080-C ... Chrome B080 Ending  
MCJ/B080-B ... Black B080 Ending



MCJ/B081-C ... Chrome B081 Ending  
MCJ/B081-B ... Black B081 Ending

## Touring

### 2 in 2 Royal Cigars Mufflers Touring Until 2016

- MCJ/A001 ... Homologated mufflers
- MCJ/1T-C ... Royal Cigar 2 in 2 Chrome
- MCJ/1T-B ... Royal Cigar 2 in 2 Black
- MCJ/remote15 ... Electronic Motor

Oval Mufflers Kit or 100 mm or 120 mm also available ... ask for part numbers

### Touring 2017 Up

- MCJ/A001 ... Homologated mufflers
- MCJ/2T-C ... Royal Cigar 2 in 2 Chrome
- MCJ/2T-B ... Royal Cigar 2 in 2 Black
- MCJ/remote15 ... Electronic Motor

Oval Mufflers Kit or 100 mm or 120 mm also available ... ask for part numbers

If you did not find your bike application ... just ask us and we give you a quote ! We have this also for the Street 750, V-Rod, Night Rod, Night Rod Special, Muscle ...



## MCJ Bags

For your Sportster's, Dyna's and Softail's MCJ have a line of Side bags with specific mount for your bike in chrome or black ... Key lock is optional to secure your bag on your bike ! Available in waterproof : Black Leather, Brown Leather and in Vintage Look ! Easy installation. The product is complete with a loom, created for every single models

### The End Cap Choice for the Royal 2 in 2 Cigars



MCJ/B029-C ... Chrome B029 Ending  
MCJ/B029-B ... Black B029 Ending



MCJ/B030-C ... Chrome B030 Ending  
MCJ/B030-B ... Black B030 Ending

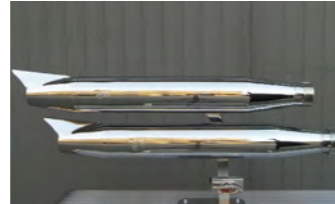

MCJ/B072-C ... Chrome B072 Ending  
MCJ/B072-B ... Black B072 Ending



MCJ/B073-C ... Chrome B073 Ending  
MCJ/B073-B ... Black B073 Ending



MCJ/B076-C ... Chrome B076 Ending  
MCJ/B076-B ... Black B076 Ending



MCJ/B077-C ... Chrome B077 Ending  
MCJ/B077-B ... Black B077 Ending



MCJ/B080-C ... Chrome B080 Ending  
MCJ/B080-B ... Black B080 Ending



MCJ/B081-C ... Chrome B081 Ending  
MCJ/B081-B ... Black B081 Ending



MCJ/B075-C ... Chrome B075 Ending  
MCJ/B075-B ... Black B075 Ending



MCJ/B078-C ... Chrome B078 Ending  
MCJ/B078-B ... Black B078 Ending



MCJ/B079-C ... Chrome B078 Ending  
MCJ/B079-B ... Black B078 Ending

If you did not find your bike application ... just ask us and we give you a quote !

<http://lineamcj.it/en>





Our exclusive products line :

Hardbody, V-factor, Power House, Power House Plus, American Motorcycle Hardware and Riderware are recognized worldwide for their top quality craftsmanship. Over the years, we have continually added new products to meet the comprehensive demands of the custom motorcycle enthusiast.

Mid-USA has over 10,000 parts for American-made motorcycles to help you create or customize your dream bike





Parts selection second to none. We've added hundreds of new parts for the 2018 catalog.  
 New lower prices on many parts for 2018.  
 We've added some cool new vendors, that are sure to appeal to more customers than ever.  
 Knowledgeable sales staff with over 75 years of combined industry experience.  
 Proudly supporting motorcycle dealers for over 33 years.

### HARDBODY VINTAGE DRILLED TAILLIGHTS FOR CUSTOM USE

Vintage taillight with drilled lens ring adds a retro look to any bike  
 Includes license plate bracket

- Finishes :
- MU11255 ... Raw Aluminum Ring & Black Bracket
  - MU11257 ... Black Aluminum Ring & Black Bracket
  - MU11258 ... Chrome Ring & Chrome Bracket
  - MU11259 ... Brass Ring & Black Bracket
  - MU11261 ... Chrome Ring & Black Bracket



### HARDBODY WIDE STYLE GENERATION II SPRINGERS

Rocker grease fittings  
 Fully assembled with a forged in-line top bracket without a built-in rake  
 The standard length Springer (24" measured from the bottom bearing to the axle center)  
 is comparable to a standard length FXST front end  
 1" O.D. steering stem designed for Timken® type bearings  
 Both rear legs are threaded for right or left brakes  
 Forged rockers for superior strength  
 Rear legs are 1 piece from the rocker to the top tree  
 The 3/4" O.D. axle kit includes a brake mount pivot with thrust washer and hub spacers  
 (custom spacers may be required depending on the wheel used)  
 Measures 9 1/4" between rockers  
 Riser mounts are on 4 3/4" centers and threaded 1/2-20  
 Available in Chrome finish or Black powder coated  
 From -6" to +10" to satisfy most of your builds !



### Number One Choice for Bobber and Retro Mods

#### HARDBODY GENERATION III BLACK AND COPPER SPRINGERS

Re-Engineered for Greater Strength and Durability  
 One inch front rails on all lengths  
 Fully assembled with a forged in-line top bracket without a built-in rake  
 The standard length Springer (24" measured from the bottom bearing to the axle center) is comparable to a standard length FXST front end  
 1" O.D. steering stem designed for Timken® type bearings  
 Both rear legs are threaded for right or left brakes  
 Forged rockers for superior strength  
 Rear legs are 1 piece from the rocker to the top tree  
 The 3/4" O.D. axle kit includes a brake mount pivot with thrust washer and hub spacers (custom spacers may be required depending on the wheel used)  
 Measures 9 1/4" between rockers  
 Riser mounts are on 4 3/4" centers and threaded 1/2-20  
 See the front end section for removable front fender mounts  
 Sizes available : 20", 22", 24"



#### HARDBODY ANTIQUE STYLE SPRINGERS

Fully assembled with in-line top bracket without built in rake (0° rake)  
 The standard length Springer (20" measured from the bottom of the lower tree to the axle center) is comparable to vintage FL model fork length  
 1" O.D. steering stem designed for Timken® type bearings  
 Use our Part 36652 neck cup conversion kit to install Springer on K Model and Sportster 1952/1981  
 Measures 8 3/4" between the axle rockers (Cast rockers)  
 Includes 3/4" O.D. axle  
 Rise mounts are on 4 3/4" centers and threaded 1/2-20  
 Universal brake rod mount is on the right rear leg for disc brakes (5/8" hole)  
 Available in Chrome or Gloss Black Powder Coated  
 Sizes available : 18", 20", 22", 24" and 26"





### COMPLETE 40 SPOKE WHEELS FOR MOST MODELS

Drop center steel rims  
 Chrome spokes  
 Available with OE chrome hub or black hub and rim  
 Includes bearings and seals  
 \* When replacing models equipped with 19" wheels with these 21" wheels you must mock-up wheel without the tire mounted and check for wheel spokes to brake caliper clearance. If wheel spokes contact the brake calipers, you must purchase custom shallow brake calipers.



### 2 1/4" TOP FUELER DRAG PIPE SETS FOR SOFTAIL

Chrome 2 1/4" O.D. tubing  
 Top Fueler drag style system, right off the drag strip  
 Includes mounting hardware  
 With O2 bung (use 12mm plug or stock O2 sensor)  
 Sold in sets



### V-FACTOR DRAG PIPES FOR BIG TWIN & SPORTSTER

Top quality drag pipes for models listed  
 Chrome plated or black primed that is suitable for heat wrapping.  
 Black primer is a protectant for rust, not a ceramic heat coating  
 Available in 1 3/4" or 2" diameter in 40" lengths  
 Slash cut tips for a performance look  
 Hidden channels for a clean look



### ENGINE MOUNT KIT FOR TWIN CAM BIG TWIN

V-FACTOR  
 Chrome Plated Engine Mount  
 Fits Big Twin 2000/2005 Twin Cam with Carb



### ENGINE MOUNT KIT

V-FACTOR  
 Chrome Plated Engine Mount  
 Fits XL Models 2004/Later  
 Replaces HD #47480-04



### TOP ENGINE MOUNT FOR 4 SPEED PANHEAD/SHOVLEHEAD BIG TWIN

V-FACTOR  
 Chrome Plated Engine Mount  
 Fits 4 Speed Big Twin 1948/1984



### SLIMLINE LEGACY GAS TANKS

Slimline Legacy gas tanks  
 Uses OE gas caps  
 2.75 gallon capacity

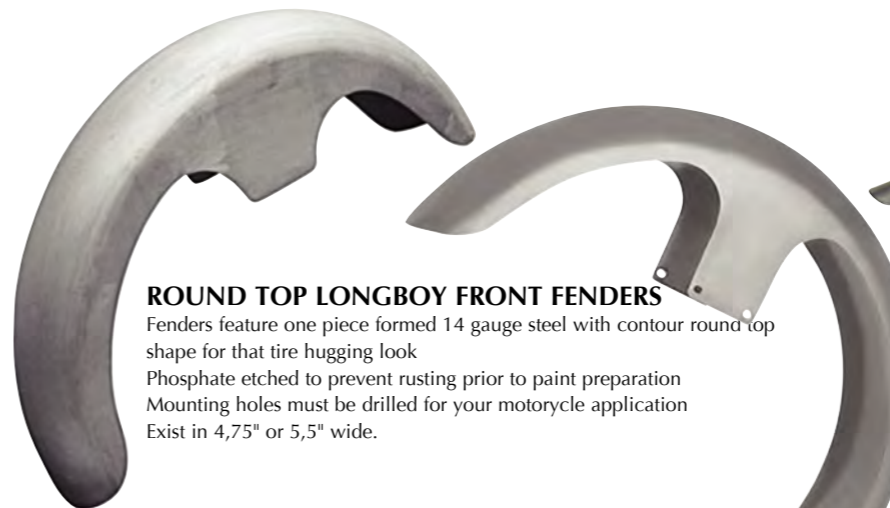

### ROUND TOP LONGBOY FRONT FENDERS

Fenders feature one piece formed 14 gauge steel with contour round top shape for that tire hugging look  
 Phosphate etched to prevent rusting prior to paint preparation  
 Mounting holes must be drilled for your motorcycle application  
 Exist in 4.75" or 5.5" wide.

### BRAKE DISCS FOR BIG TWIN & SPORTSTER

V-FACTOR  
 Front and Rear Disc, 11 1/2" O.D.  
 In polished finish or Black  
 Fits Big Twin 1981/Later & Sportster 1979/Later  
 Includes adapter ring that reduces I.D. to 2" for 1984/1999 models



### RIBBED MUSTANG TANKS

Old School Ribbed Style  
 Tanks measure approximately 17" long x 11.5" wide with a 2" tunnel  
 3.3 gallon capacity  
 3/8" NPT gas outlet on right side  
 Rear of tank has 1/4" crossover outlets  
 We also have the matching ribbed front fenders



### HEFTY APE HANGERS FOR CUSTOM USE

Fits 1982/Later models, including Fly-By-Wire  
 MU40019 Chrome Plated, with 12" Rise  
 MU40020 Black Handlebar with 12" Rise  
 MU40021 Chrome Plated, with 14" Rise  
 MU40022 Black Handlebar with 14" Rise with 12" Rise  
 1 1/2" diameter  
 Available in finishes as listed  
 5" pull back  
 Drilled for internal wiring



### V-FACTOR OE STYLE FRONT BRAKE CALIPER FOR 2000/LATER MODELS

Direct replacement for the 4 piston type factory unit  
 Eliminates the long down time if your original caliper was at the chrome shop  
 Includes sintered metal brake pads that are compatible with most types of brake discs  
 Use with your original mounting hardware



### HARDBODY DUAL PISTON BRAKE CALIPERS & BRACKETS FOR MOST MODELS

CNC machined 6061-T6 billet aluminum, designed to eliminate flex  
 Anodized aluminum piston  
 Centerless ground or exacting tolerances  
 Quad seal for smooth action  
 Light and compact  
 Front or rear applications  
 Requires separate caliper bracket



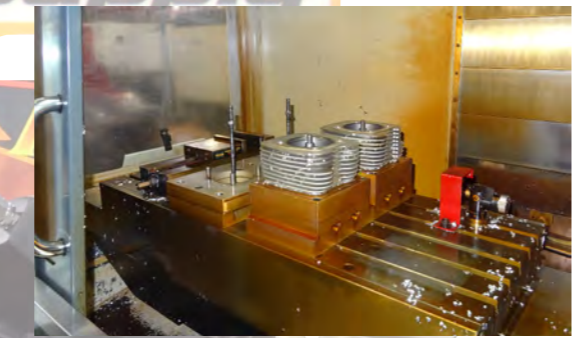
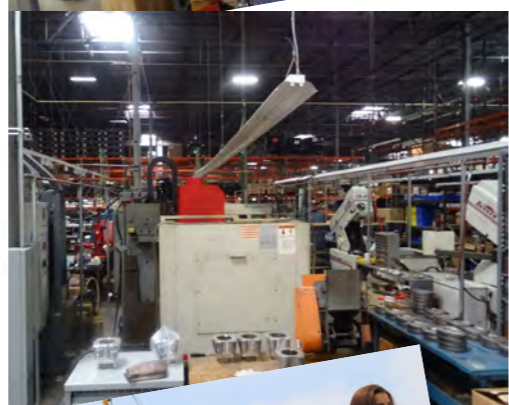

Midwest Motorcycle Supply, Est. in 1971, is one of the world's leading distributors for aftermarket parts and accessories for American made motorcycles. Through the owned label Ultima, Midwest offers the famous King Spoke Wheels, 3.35" and 2" belt drives, trannies, frames, front ends, exhausts, ignition & charging systems and their state of the art assembly line facility in Pevely Missouri brings you the Evo type and Shovelhead engines offered in various finishes including the brilliant diamond cut.





# MIDWEST



## Shovel 96 Engine by ULTIMA

For those who are looking for a quality shovelhead engine at a realistic price, look no further! Our engineers have developed what we believe to be a superior motor that will please even the most die-hard shovelhead enthusiast. This Ultima® shovelhead motor offers modern technology in a nostalgic exterior, including dual plug heads, compression releases & 3-bolt exhaust manifold. 96 C.I. shovelhead engine carries a 6 month limited warranty from original date of purchase. For additional warranty details see SHOVELHEAD owners manual (included with purchase)

\*NOTE: INTAKE MANIFOLD AND CARBURETOR NOT INCLUDED. 96 CI

**MW/298-210 ... ULTIMA® 96" CUBIC INCH SHOVELHEAD ENGINE**

**MW/298-212 ... ULTIMA® 96" CUBIC INCH SHOVELHEAD ENGINE Polished**

**MW/298-366 ... ULTIMA® 96" CUBIC INCH SHOVELHEAD ENGINE Blackout**

## New Competition Serie "BLACKOUT" Engines

**MW/298-362 ... 113ci Complete Engine, Black (regular) Finish**  
Rated Output 113 C.I. 120 HP with 120 LB FT Torque.

**MW/298-364 ... 127ci Complete Engine, Black (regular) Finish**  
Rated Output 127 C.I. 140 HP with 140 LB FT Torque.



Available in 5 different sizes

from 100ci to 127ci

and 3 finishes

Natural, Black & Chrome or Polished

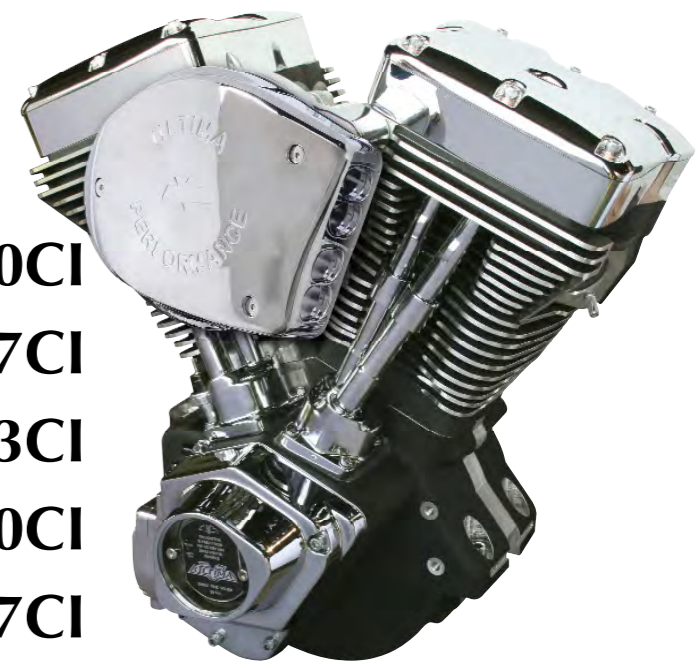
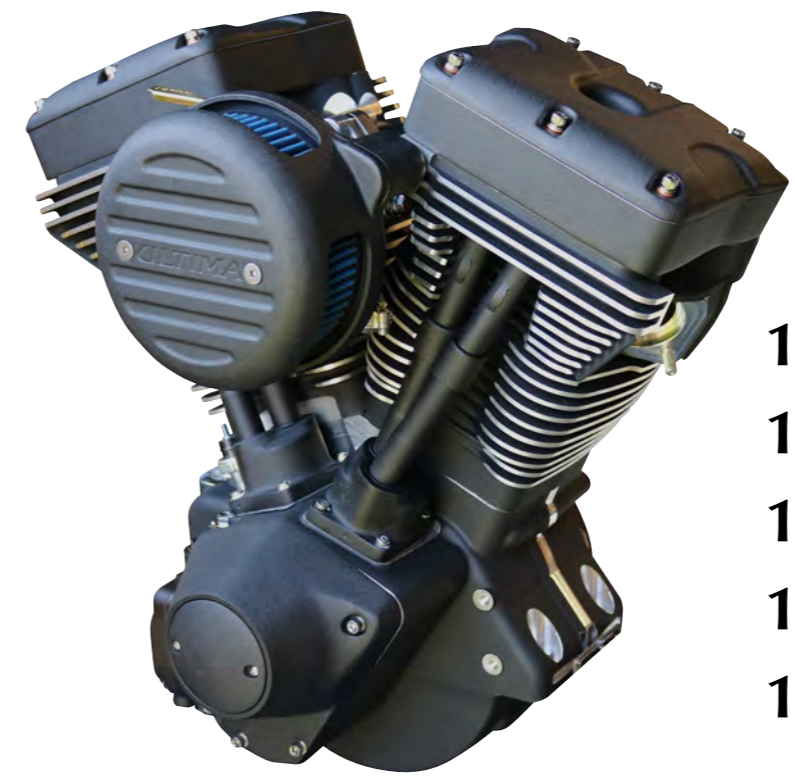

- 100CI
- 107CI
- 113CI
- 120CI
- 127CI





# MIDWEST



All that you need for your builds or service ! ... All that you need for your builds or service ! ... All that you need for your builds or

A choice of 40 spokes, 60 spokes, 80 spokes and also Fat Spokes wheels at affordable prices with a good quality !



Billet Wheels with assorted disk and pulley at affordable prices with a good quality !





MOONEYES



*Mooneyes products and logos are an indelible part of Hot Rod nostalgia, easily recognizable to gearheads and novices alike. We take pride in producing high quality products that look great and get the job done right.*

*Mooneyes produces Moon tanks, Moon discs, and valve covers right on site in our Machine Shop. We also supply various parts and accessories for hot rods, rat rods, and kustom creations, as well as an expanding line of motorcycle products.*

*Located in the same place since it all started back in the 1950s,*

*Mooneyes is located in Santa Fe Springs, California.*

*All visitors are welcome! Come on in, say hello, and be sure to ask for a shop tour.*











national cycle



*The company known today as National Cycle, Inc. started in Chicago, Illinois in 1937 as Nation's Cycle Center. The company was founded by a young man, Mr. Gordon Willey (1903-1989), who believed that success in business required "Total Customer Satisfaction". This business philosophy was the beginning of a long and successful tradition. It's a tradition we maintain today as we continue building the finest motorcycle windshields and accessories riders can buy.*

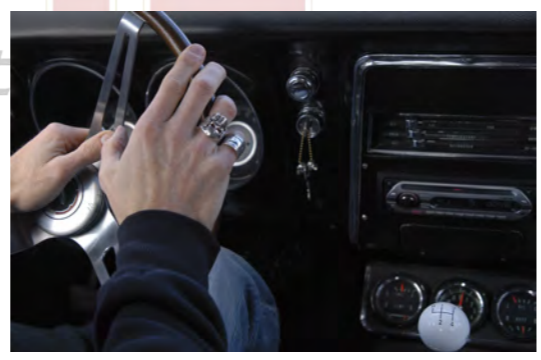



# NATIONAL CYCLE



National Cycle, Inc. is the world leader in motorcycle windshield manufacturing, with more distribution than any other windshield company in the world. We are the OEM supplier to BMW, Harley-Davidson, Honda, Kawasaki, Polaris, Suzuki, Triumph, and Yamaha – companies who share our philosophy of quality design and manufacturing. National Cycle has developed more innovations and holds more patents for the design and production of windshields than any other company in the industry. We listen to our customers and work hard to maintain our leadership position. We are proud that we continue to design, engineer and manufacture our fine products at National Cycle, Inc. U.S.A.



The typical airflow pattern of the wake from most windshields is called a van Karman vortex. At speeds of 50-90 mph, the air swirls off the windshield in an approximate 90-degree segment of rotation, hits the bottom of the rider's neck on the way up, and curves off the shoulder at approximately 45 degrees. We gave the VStream® its name for the shape it takes at the upper edge. The patented "V" shape is so quiet because it pushes this vortex out and away from the side of the rider's head. The rider's helmet then resides in still air, and the passenger's environment is greatly improved as well. Reduced wind noise... less turbulence... superior strength... perfect style. The VStream revolution is here!

National Cycle's Wave® Windscreens are available for late-model FLHT, FLHX and FLTR motorcycles. Quality is evident when you feel the thick gauge, precision cut, smooth radiused edge on these windshields. Quantum® hardcoated polycarbonate delivers outstanding strength and unbeatable scratch resistance. It's stylish... sleek... and sexy. It's the new Wave. Ride it!



Wind In Your Hair When You Want It... Full Wind Protection When You Need It!™ Riders enjoy unprecedented convenience, quality and functionality with this innovative line of quick release windshields, available in four sizes. SwitchBlade® Windshields utilize our SwitchBlade Mounting System, which lets riders install, switch, or remove their windshield in less than 5 seconds – with no tools! Switch styles... Switch attitudes... with SwitchBlade!

The newest addition to our Quick Release family is the Wave QR® Fairing – a totally new look in wind protection for Harley-Davidson® motorcycles. It uses the same mount kits as our well-known SwitchBlade® and Spartan® windshields, so riders now have a lot of options, sizes and styles to choose from! Wind In Your Hair When You Want It... Wind Protection When You Need It!™



**national cycle**

[www.nationalcycle.com](http://www.nationalcycle.com)



Take a ride on the dark side! The Spartan® Windshield's stainless steel frame finished in stealth black powdercoat puts this full size windshield offering in a category of its own. Spartan leads the way in high value/low cost. Quantum® hardcoated polycarbonate, quick release windshields for Harley-Davidson® riders!



Is the original shield on your Harley® looking old, yellowed or scratched? Enjoy optical quality and durability that is superior to OEM and other aftermarket replacement screens. National Cycle's tough 4.0mm hardcoated polycarbonate is the toughest and strongest windshield material you can buy.



Long favored by cruising riders because of their ruggedness and protection, National Cycle Heavy Duty™ Windshields are available in a variety of heights and styles to provide comfort and good looks. National Cycle Heavy Duty windshields are not "universals". They use our model-specific mounting kits (sold separately) to ensure excellent fitment, ease of installation, and flexible height adjustment.



For that custom look at a very affordable price, nothing beats the National Cycle Dakota™ Windshield. It gives a custom look to bikes with exposed fork tubes. The Dakota 3.0™ comes complete with our patented variable width/diameter fork mounts, and is available in two styles for high or low turn signals.



Our Classic Beaded Windshield for the Harley-Davidson® FXSTS and FXSTSB is optically superior and trimmed with a mechanically-applied traditional beaded edge. The highly polished chrome mounts attach to the OEM handlebar risers to provide a significant range of individual adjustment for height and rake.



This small, sporty shield will look great on your bike with its almost invisible mounting system. Plus, a quick turn of the wrench lets you adjust the shield's height and/or rake angle to suit your style preference or wind protection needs – in less than a minute. Highly engineered, beautiful, and versatile... you'll love it!





# NATIONAL CYCLE



plexifairing™

We introduced the Plexifairing™ in 1984, and it was an instant hit with riders worldwide. This windshield has truly gone "platinum". And we sell as many today as we did over two decades ago, proving that superb wind protection, rugged construction and quality materials are things that never go out of style.

The included, patented QuickSet™ hardware ensures easy installation and removal, leaving minimal hardware on the bike when the shield is off.



Street SHIELD Street SHIELD EX

The Street Shield™ and Street Shield EX™ are your windshields of choice when your height or riding position requires a bit more coverage than our popular Deflector Screen™ offers. Both feature our patented NoHole Ballssocket™ technology.

A sturdy four-point mounting system with height adjustment fits almost any bike and any rider.



Windshield Accessories

Holdster™ Windshield Bags offer convenient up-front storage for your gloves, sunglasses, brush, garage door opener, tool case, etc. Unlike leather bags that tend to dry out and become stiff with use, our bags will stand the test of time.

We also offer an excellent Windshield Storage Bag that will protect almost any size shield when it's not on your bike.



Rear End Touring Accessories

Sometimes you need to carry along more than just a toothbrush and a credit card. National Cycle's popular Cruiseline™ Saddlebags make it easy to turn your bike into a pack mule for long trips or just around-town convenience.

These durable, locking bags fit almost any cruiser using our model-specific Cruiseline™ Quick Release Mount Kits.



DEFLECTOR SCREEN™

Our Deflector Screen™ is one of our trademark products and is the most copied windshield worldwide. But now it's been upgraded to our exclusive Quantum® hardcoated polycarbonate for maximum impact strength and unbeatable scratch resistance!

It's easy to mount and easy to remove, and it's rake adjustable for the performance and looks you want!



MOHAWK™ Windshields

Continuing the minimalist, sporty tradition of our famous Flyscreen®, the new Mohawk™ features a taller and wider size with a special "V" profile for added wind management.

As with our Flyscreen, the versatile Mohawk is adaptable to many motorcycles.



Deflectors for Wind and Weather Control

Do you hate chilly and damp hands? Does the riding season seem too short? National Cycle Hand Deflectors are an economical solution for extending the riding season. Coupled with a windshield, Hand Deflectors protect your entire upper body from cold wind and rain.



Deflectors for Wind and Weather Control

Chrome Lower Deflectors improve the performance of your windshield by preventing unwanted turbulence around your waist and unwanted updrafts on your back.

Chrome Lower Deflectors can be used together with a SwitchBlade®, Heavy Duty™ or Dakota 4.5™ windshield and a National Cycle Spotlight Bar for an integrated front end appearance.

SwitchBlade® or Heavy Duty™ Windshield Mount Kit required for fitment. Choose Your Vehicle to view Applications:



Windshield Accessories

Holdster™ Windshield Bags offer convenient up-front storage for your gloves, sunglasses, brush, garage door opener, tool case, etc. Unlike leather bags that tend to dry out and become stiff with use, our bags will stand the test of time.

We also offer an excellent Windshield Storage Bag that will protect almost any size shield when it's not on your bike.



Peacemakers Exhaust Systems

Imagine being able to start up your Harley-Davidson® for an early morning ride without angering your neighbors. Imagine enjoying a deep, powerful exhaust note without cringing whenever you pass a police officer or a school zone.

National Cycle's Peacemakers® Exhausts make those dreams a reality!

Our system enables you to get the sound you want, when you want it – while you ride!





# noline

nouvelles Lingettes de Nettoyage



*With more than 10 years experience in the maintenance product, we decided in 2015 to create New Cleaning Wipes : Noline*  
*We have taken into account expectations of our customers and composed a healthy product, which does not require any safety pictogram and even benefits from a good standart Ce 1935-2004.*  
*Moreover, No Line is solvent free, acetone free and silicone free.*  
*Noline is able to clean, degrease, protect and shine any material :*  
*Paint, plastic, aluminum, glass, steel, leather, wood, composite materials ...*  
*It is a simple product made with a high-quality impregnated and ready to use nonwoven wipe.*





# NO LINE

- WASH
- DEGREASE
- ANTI-DUST
- PROTECT
- WATER REPELLENT
- POLISH

Easy to use / Everywhere  
 Can be used on all surfaces  
 Number of wipes / cost of washing  
 Healthy product :  
 Does not dry or leave any greasy residue  
 Food standart EC 1935-2004  
 Can be used on wet surfaces  
 Cleans matt paints without making them shiny  
 The user can use it on motorcycles, cars, home, others  
 ...  
 The more the products is used, the less need to use



Two sizes suitable for use  
 No expiration date  
 Separate microfibre  
 French technology  
 High margin compared to demo time  
 Immediate result if demo to a customer



**NO/LP0011 ...**  
 Pack of 10 Large Box of 80 wipes + 10 Microfiber  
 + PLV and flyers



Large Box of 80 Wipes  
 + Microfiber



Small Box of 30 Wipes  
 + Microfiber

**NO/LP0012 ...**  
 Pack of 12 Small Box of 30 wipes + 10 Microfiber  
 + PLV and flyers





PAUGHCO  
INC

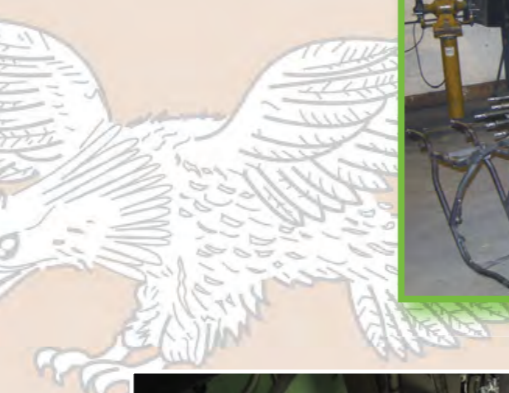

Carson City,  
Nevada



*For the past 49 years Paughco has been providing the custom and restoration Harley-Davidson market with the most diverse, highest quality line of products available. Paughco is a true family business founded in 1952 by Bob Paugh to provide cutting edge technical and components support for the Department of Defense and Aerospace industry. They work also for the Apollo Space program in the late 60's. Ron Paugh was parking a name of himself as a prominent "Chopper" builder in southern California and ask to his father Bob if he can reproduce the early HD primary covers ... and it was the beginning of purpose of producing the finest in custom and replacement parts and accessories. Bob told to his father that he could produce virtually anything a chopper enthusiast could want, it was no idle boast. Within a couple of years, Paughco was producing handlebars, sissy-bars and other bolt-on followed by what was and remains today. The company with thousands of unique products, became the number one choice of consumers worldwide.*

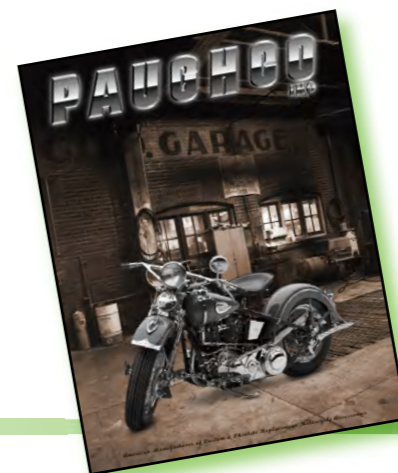





# PAUGHCO



## The Ultimate In Springers Since 1969

The largest, most respected line of Springer front ends in the industry, just got bigger and better. On the following pages, you'll find an unparalleled selection of NARROW, WIDE and WIDE SHOCK Springers to meet every need and application. Second-to-none in quality and performance, our Springers come fully assembled with a 7/8" or a 1" neck stem, and a Dog Bone or Glide-Style top clamp. Special features include straight, twisted or Wishbone front legs, tapered oval rear legs, flawless craftsmanship, and Paughco's award-winning chrome finish.



### Handlebars

Choose from a variety of complete handlebar kits with controls in your choice of chrome or powder coated black finishes, handlebars only in a selection of unique bends for modern and vintage Harley-Davidsons, or the custom risers needed to pull it all together



# PAUGHCO



## Gaz Tank

Choose from a variety of universal or model-specific gas and oil tanks for Harley-Davidson motorcycles all the way back to the 1930's.



## Swoop Dished Custom Gas Tank

feature a special reversed swoop-shaped panel in their sides that make for one-of-a-kind custom styling. Available in 'Standard' and 'King' sizes, these tanks both have 1 1/4" Frisco-style shallow tunnels for that high-mount styling.



## Frames ... and Captain America Special Parts

Wishbone frames available so that you can build your own Captain. Original 4-speed frame for a perfect copy or even a 5-speed frame for updating to a Softail driveline. Specific Captain America seat, sissy bar, pipes, flag painted fuel tank, make your own !



## Exhausts

a variety of drag pipes, fancy endcaps, custom systems and repro headpipe sets for all Harley models including 45" WL models as well as all of the popular Harley-Davidson 74" and 80" UL Flathead Big Twins.





Specializing in Air Suspension for the Motorcycle Industry

# BLEED FEED TECHNOLOGY PLATINUM AIR SUSPENSION

*"It's all about the Ride"*



MIKE FERRIS THE OWNER OF PLATINUM AIR SUSPENSION (LEFT) WITH COMPANY R&D MANAGER EDGAR ARAYA



Specializing in Air Suspension for the Motorcycle Industry

# BLEED FEED TECHNOLOGY PLATINUM AIR SUSPENSION

Today it is common to find air suspension systems on motorcycles, even as OEM equipment, but one of the forerunners in the market is Platinum Air Suspension. The Southern California based company has air ride systems for all Harley Davidson, Victory, Can-Am, Metric, Street Bikes, Boss Koss, Indian and custom applications.

The constant product development undertaken by Mike and his team at their manufacturing plant in Fullerton, California.

This is just a sample of the development and types of work that drives Platinum Air Suspension for more than 10 years.

Our products have been put to the test by thousands of customers over our 10+ years in the motorcycle industry, and we will continue our dedication to manufacturing reliable and quality products for years to come. At Platinum we believe every customer is unique, and our Bleed Feed system allows you to make your ride equally unique.





# PLATINUM SUSPENSION



## Evo Bleed Feed Kit



One of the company's bestselling packages is its 'Bleed Feed' system, which allows the rider to control both ride height and rebound. Developed by Platinum, Bleed Feed technology raises the bar as the industries best air suspension riding system. This technology allows you to control both front pressure & back pressure for the ultimate custom riding experience. "With this technology riders can have a lowered look & comfortable ride at any desired height." - Mike Ferris

Kit includes the following: (2) Air cylinders machined from 6061 T-6 billet aluminum, the rods and end caps are machined from stainless steel, steel splash guard, air-control valve, DOT-approved 1/4" line and fittings, air compressor, switch harness, hardware and line cut-

## Evo Simple Kit



For some customers less is more, and for them Platinum also provides our Simple System, made from the same quality components as the Bleed Feed system. This system allows a rider to control their ride height with positive lift, but doesn't provide the same rebound control as Bleed Feed. Platinum Air Suspension offers a Simple system for most H-D, V-Twins, Metric, Cruisers, Street Bikes & Custom Applications.

## Ball Mill & Color Options



## FL Shocks



Min. Retracted 9 1/4" Max. Extended 13" Rear Lift: 3 3/4" Shock Travel: 3 3/4" Diameter: 2 1/2"

Kit includes the following: (2) Air cylinders machined from 6061 T-6 billet aluminum, air-control valve, DOT-approved 1/4" line and fittings, air compressor, switch harness, hardware and line cutter.

## V-Rod Shocks



**Platinum's Bleed Feed Air Ride Systems are available for all Harley Davidson, Indian, Victory, Can-Am, Metric, Street Bikes, Boss Hoss, and custom applications.**





# PLATINUM SUSPENSION



## Kits for the 2018 Softails are also available !

### Softail 2018 Up Bleed Feed Kit ..... PAS/2018SBF

All is installed in a box ... Kit on the bike in one hour !



Softail 2018 Up Bleed Feed Kit ..... PAS/2018SBF



H-D / V-Twin / Custom	PART #
FLH's / FLHT's Bleed Feed Kit	PAS/1702FLH
FLH's / FLHT's Bleed Feed Kit - High Gloss Black	PAS/1702FLHB
FLH's / FLHT's Simple Kit	PAS/1686RKD
FLH's / FLHT's Simple Kit - High Gloss Black	PAS/1686RKDB
FLH's / FLHT's Long Travel Kit	PAS/1702FLHSLT
FLH's / FLHT's Long Travel Kit - High Gloss Black	PAS/1702FLHSLTB
FLH's / FLHT's Long Travel Front and Rear Air Ride Package ( Pucks )	PAS/1986SLTFRTP
FLH's / FLHT's Long Travel ( Black ) Front and Rear Air Ride Package ( Pucks )	PAS/1986SLTFRTPB
FLH's / FLHT's Long Travel Front and Rear Air Ride Package ( Pistons )	PAS/1686SLTFRTC
FLH's / FLHT's Long Travel ( Black ) Front and Rear Air Ride Package ( Pistons )	PAS/1686SLTFRTCB
Twin Cam Softail Bleed Feed	PAS/0000TBF
Twin Cam Softail Bleed Feed - High Gloss Black	PAS/0000TBFB
Twin Cam Softail Simple Kit	PAS/0000ST
Twin Cam Softail Simple Kit High Gloss Black	PAS/0000STB
Twin Cam Softail Front and Rear Air Ride Package ( Pucks )	PAS/0000TBFFRTP
Twin Cam Softail Black Front and Rear Air Ride Package ( Pucks )	PAS/0000TBFFRTPB
Twin Cam Softail Front and Rear Air Ride Package ( Pistons )	PAS/0000TBFFRCP
Twin Cam Softail Black Front and Rear Air Ride Package ( Pistons )	PAS/0000TBFFRTCB
EVO Softail Bleed Feed Kit	PAS/8699EBF
EVO Softail Bleed Feed Kit - High Gloss Black	PAS/8699EBFB
EVO Softail Simple Kit	PAS/8699SE
EVO Softail Simple Kit - High Gloss Black	PAS/8699SE-B
EVO Softail Front and Rear Air Ride Package ( Pucks )	PAS/8699EBFFRTP
EVO Softail ( Black ) Front and Rear Air Ride Package ( Pucks )	PAS/8699EBFFRTPB
EVO Softail Front and Rear Air Ride Package ( Pistons )	PAS/8699EBFFRTC
EVO Softail ( Black ) Front and Rear Air Ride Package ( Pistons )	PAS/8699EBFFRTC
V-ROD Bleed Feed Kit	PAS/1702VRBF
V-ROD Bleed Feed Kit - High Gloss Black	PAS/1702VRBFB
V-ROD Simple Kit	PAS/1702VRD
V-ROD Simple Kit - High Gloss Black	PAS/1702VRDB
DYNA - Deluxe - Simple Kit	PAS/1702DD
DYNA - Deluxe - Simple Kit - High Gloss Black	PAS/1702DDB
Sportster Simple Kit	PAS/1202SD
Sportster Simple Kit - High Gloss Black	PAS/1202SDB



### FL Front and Rear Air Ride Package



+

or



Front Kit only are also available separately ... just ask !

In Puck or Pistons versions



### Softail Evo and Softail Twin Cam Front and Rear Air Ride Package



+

or



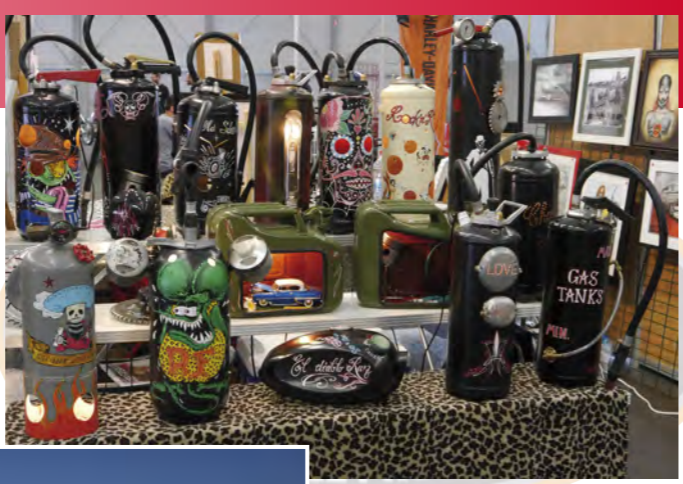

*Pro-One began in 1989 with an eight page catalog, ninety part numbers and the desire to be the most recognized supplier of billet aluminum accessories in the world. Since that time we have learned that our customers insist on the very best products available.*

*Our goal is to provide you, with the very finest products and service in the industry.*

*It is with sincere appreciation that we dedicate this, our finest product line-up to date, to you, our valued customer.*

*It is you who have shown your interest in our products and your continued support over the past 25 years that has made Pro-One the top supplier of genuine quality motorcycles and accessories in the world.*

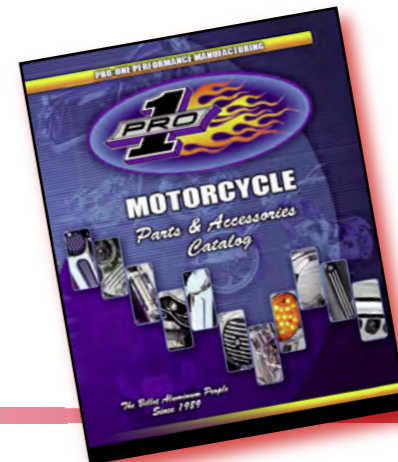



# PRO-ONE

A very large range of quality billet mirrors in finishes chrome or Black anodized to satisfy your builds ! Sold each or in pair depending of the chosen models.

Pro-One wrote the book on Billet Motorcycle Mirrors nearly 20 years ago when we came out with our unique design that featured no visible screws on the back of the mirror head. The pivot mechanism is totally hidden inside the mirror head. The super clean look releasing was storm like in the motorcycle industry! We were the first to use this innovation, and though our Billet Mirrors have often been duplicated, their quality has never been equaled.



Pro-One was one of the first to introduce Billet Triple Trees for Harley-Davidson motorcycles nearly 20 years ago! Our latest designs are super popular with custom bike builders and "shade tree" builders alike. Our Billet Triple Trees are designed for the Harley 41mm "Wide Glide" configuration. They're beautifully CNC machined from aircraft quality billet aluminum for the ultimate in form and function and accept 41mm fork tubes. We offer styles with or without our built-in turn signals.



The original is still the best! Pro-One invented the Billet Turn Signal Bar way back in the early 1990's and they're still going strong. Pro-One Billet Turn Signal Bars are CNC machined from Billet Aluminum and finished in your choice of Chrome or durable Black Anodized finish. Designed for Harley-Davidson Wide Glide or Narrow Glide front ends. Just pick your size and style and you're good to go!



**Lower Legs**  
The original is still the best! Pro-One was the first to come out with solid Billet Aluminum Lower Legs way back in the early 1990's. Our latest style is our 114020 Smooth Round Lower Legs. They're designed for 41mm "wide glide" Harley-Davidson applications and include everything you need to customize your front end. Our Pro-One Lower Legs include a 3/4" axle, 2 Billet Caliper Mounts (so you can go with a single or dual disc setup), Billet Fender Brackets, and all necessary hardware.



**Stash Tube**  
When only the best will do, go with Pro-One! Pro-One invented the original Stash Tube nearly 20 years ago and it's still going strong. Great for "stashing" just about anything. Solid Billet Construction, CNC machined, and your choice of Chrome or Black Anodized finish. Once you know the size of your frame tube, the rest is easy; just order your Stash Tube with the correct size clamp.

## Oil Filter Adapter

Our Slimline Oil Filter Adapter for Harley-Davidson EVO motors is the way to go when you want to get rid of the stock lines and set your Harley up with custom oil lines. Popular with custom bike builders and shade tree builders alike. Replaces the stock oil filter mount on Harley EVO motors and simply bolts to the stock location.



## Oil Cooler

Pro-One invented the Billet Oil Cooler for Harley-Davidson motorcycles nearly 20 years ago and they're still going strong! It's hard to beat the custom look our our Billet Oil Coolers. Although they were originally designed to work with the Harley-Davidson EVO motor, they can also be adapted to TC88 motors with a Jagg 4600 Offset Oil Filter available from many suppliers.





# PRO-ONE

## Hydraulic Clutch Actuators

When you're ready to go with the "easy-pull" of a Hydraulic Clutch, Pro-One has you covered. Our Hydraulic Clutch Assemblies are state-of-the-art! They feature CNC machined Billet Aluminum construction, Viton seals, and a hard-anodized piston. They come with complete instructions. You even get a choice of Black Anodized or Chrome finish. Just supply your hydraulic hand controls, clutch line and you're good to go! Bolt one on your Harley-Davidson motorcycle today!



## Ignition Key Switches

Pro-One offers a couple of universal ignition switches to cover most custom Harley-Davidson applications. Popular with many bike builders for use on custom bikes.



## Taillights

Pro-One offers an assortment of custom tail lights to customize your Harley-Davidson motorcycle or metric cruiser. These tail lights are universal application and can be adapted to a wide variety of installations on a wide variety of motorcycles.



## Wire Harness

Here's the kit you need when it's time to re-wire your Harley-Davidson motorcycle with the "split tanks". Great for custom builds too that are set up for split tanks. Our Pro-One #400909 Wire Harness comes complete with flashers, relays, bulbs, and a new key switch with 2 keys. Color-coded instructions included with every kit!



## 4 Pistons Calipers

Pro-One has the best deal on 4-Piston Billet Calipers! Our calipers are CNC machined from 6061-T6 Billet Aluminum, carefully polished, and then Chrome Plated or Black Anodized to perfection. All calipers come complete with Brake Pads and are ready to bolt on to your custom or stock Harley-Davidson. Increase your braking power and save money at the same time!



## Billet Motor Mount

Check out our line of Motor Mounts, Coil Covers and accessories for the Harley-Davidson EVO motor. With our modular approach, you can get the look you want by choosing your own custom setup.



## Grips and Levers

Pro-One has you covered for custom Grips for your Harley-Davidson motorcycle! Our grips fit all Harley-Davidson dual throttle cable setups on 1" handlebars. Note: does not fit 2008 & later FL Touring models with electronic throttle. Toss your stock Harley-Davidson levers and install a set of Pro-One Billet Levers for a quick, custom look! Machined from solid Billet Aluminum and then finished off in your choice of Black Anodized or Chrome finish. Just swap over your stock plastic bushings and springs to your new Pro-One Billet Levers and you're ready to go. Easy to install as they install just like the stock







*Since 1989 RC Components has been recognized as the premier manufacturer of motorcycle wheels serving both the aftermarket and custom bike builder.*

*We have grown to over 10,000 dealers worldwide in 36 countries.*

*Our brand is known for innovative wheel designs, quality and un-matched 7 year chrome warranty. All of our products are designed, engineered and manufactured under one roof in Bowling Green, KY.*

*Quality starts within, and because we control the process we control the quality.*

*Our customer service and passion for our products and the industry in which we serve is second to none. We are committed to 100% customer satisfaction with the goal of exceeding our customer's expectations and won't stop for anything ... today's motorcycle enthusiasts .*





# RC COMPONENTS



## Our Wheels

Quality starts on the inside and for over 20 years RC Components has been the industry pioneer. We introduced the first billet aluminum wheel, matching pulleys and rotors and have championed the industry since with our unique styles and designs. We offer direct drive, cush drive, and more shaft drive metric applications than any other wheel company. We control the process and do not try and outsource the machining, polishing, or chroming of your wheel. We use state of the art CNC machines to cut the designs to exacting standards then hand polish each wheel. We then use a multi-step nickel chroming process providing the highest resistance to corrosion, which is why we can offer an industry leading 7 year chrome warranty. To top things off, we use a hexavalent chrome providing the most brilliant finish possible with no tints of yellows. Better finish...Better looks.... Better durability. Our process and our people are what set us apart from any other wheel manufacture. We invite you to browse our catalog and join the many thousands who are riding on style today with our



**All our Wheels are available in these sizes !**

**and most of them in different finishes :**

**Polished - Chrome - Eclipse - Flipside - Twilight - Black**

**Just ask for a quotation in minutes for your needed sizes and finishes !**

### Front Wheel Sizes available

- 16 x 3,5"
- 17 x 3,5"
- 18 x 3,5"
- 18 x 4,25"
- 19 x 2,15"
- 19 x 3,0"
- 21 x 2,15"
- 21 x 3,5"
- 23 x 3,75"
- 26 x 3,75"
- 30 x 4,0"

### Rear Wheel sizes available

- 16 x 3,5"
- 16 x 5,5"
- 17 x 3,5"
- 17 x 6,25"
- 17 x 12,0"
- 18 x 3,5"
- 18 x 4,25"
- 18 x 5,5"
- 18 x 8,5"
- 18 x 10,0"
- 18 x 10,5"
- 18 x 13,0"
- 20 x 10,0"



Prowler Eclipse



Tempest Chrome



Drifter Chrome

### CNC Machining

RC has a state-of-the-art machine shop consisting of several CNC machines that cut volume production for many well known OE motorcycle companies as well as 1 - Off Design wheels, spinners, pulleys, rotors, and other aftermarket motorcycle components.



Savage Eclipse



Striker Special Chrome/Black



Alien Eclipse

### Chroming

Our in-house chroming operation is what sets us apart from the remainder of the after market industry. Controlling this process in-house and tailoring it toward motorcycle products is why RC has the best looking chrome while offering the best lead times in the industry.

## 27 Different Design and 4 different finishes !

### RC Engineering

RC has an on-site engineering staff that can take a dream and make it reality. They use CAD Design and CAM Programming to machine prototypes of concepts dreamed up by any of RC's employees. After finalizing the design the product is sent out for strength testing to ensure the product passes the designated safety requirements.

### Research and Development

After finalizing the design the product is sent out for strength testing to ensure the product passes the designated safety requirements. The new product is also fit tested in-house and placed on a bike for road testing. The last task before selling the product to the public is to name it - where employees at RC get to cast there vote on the name of the new style.

### Matched Pulleys and Disk are available





## Air Strike Air Cleaner

A stylish CNC machined billet aluminum faceplate matched to our most popular wheel designs, coupled with a high-flow K&N performance air filter. Our newly designed Air Strike base plate incorporates a velocity stack improving both horsepower and torque. Hidden crank case breathers eliminate hoses and brackets for a clean custom finish while enhancing air flow.



Prowler Eclipse

Prowler Chrome



Savage Chrome



C-Zar Eclipse



Holeshot Chrome



Apex Chrome



Calipso Chrome



Tempest Eclipse



Temper Eclipse

## RC Comp 4.0" Exhausts Slip On for 1995 Up Touring Models

Straight tough louvered core increases horsepower  
Awesome performance right out the box  
True dual sound without the dual cost  
Interchangeable billet end caps  
Excalibur Eclipse, Gatlin Eclipse and Rival Eclipse End Caps models could be ordered in XXL



Blitz Black



Blitz Chrome



Blitz Black



Excalibur Chrome



Excalibur Eclipse



Excalibur Eclipse



Thunder Black



Thunder Chrome



Thunder Chrome

Exhaust tips for the 4.0" Slip On are available in 11 different models and 2 finishes  
Blitz, Edge, Excalibur, Gatlin, Rival, Rogue, Shackle, Slash Cut, Thunder, Vapor and Wrench

## RC Comp 4.5" Exhausts Slip On for 2010 Up Touring Models

Each muffler features a full length 4.5" diameter muffler body with a precision tuned 3" stepped core baffle. This unique baffle design-transitions from a 2.5" louvered core into a ceramic wrapped 3" perforated baffle, which works to produce a deep smooth rumble while providing you the increased horsepower and torque you are looking for. Customize the look of your new RCX 4.5" Slip On Mufflers with your choice of 10 unique exhausts tip design. Mufflers are also available in chrome or a rich ceramic black finish

Exhaust tips for the 4.5" Slip On are available in 5 different models and 2 finishes  
Excalibur, Gatlin, Rage, Rival and Torx



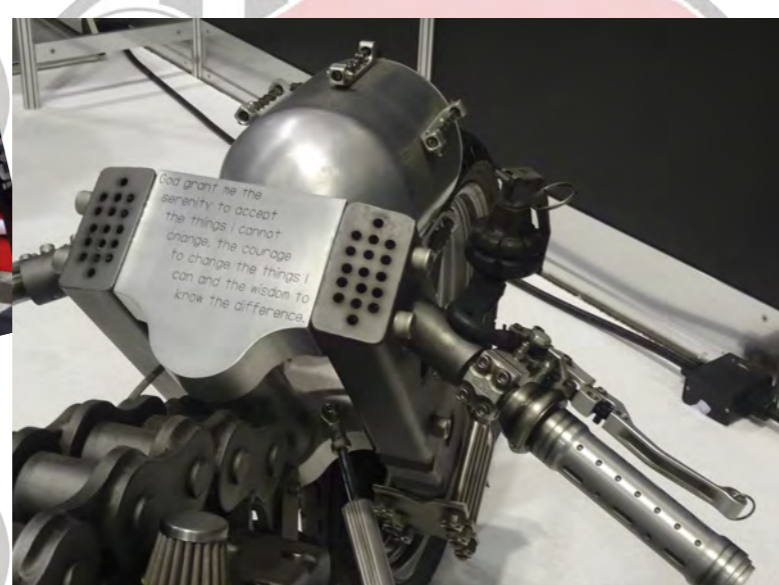

*Red Line ... Since 1979*  
*In 1979, Red Line Synthetic Oil began creating lubricants for the racing industry. Today, we manufacture more than 100 quality products, including motor oils, gear oils, assembly lubes, fuel additives and our popular Water Wetter cooling additive for the automotive, motorcycle, marine and industrial markets.*





# RED LINE



## WHY RED LINE ?

Red Line has a reputation with racers and enthusiasts alike for creating products that perform and protect better than any on the market.

No compromises.



Your Harley wants better raw materials and more ZDDP than other brands offer.

### 20W50 MOTORCYCLE OIL

Designed for the latest Big-Twin motorcycle engines that specify 20W50 motor oil, including Evolution, Twin Cam and aftermarket engines of similar design  
Superior film strength through the use of ester base stocks for protection and ring seal  
Extended drain intervals over other brands due to higher quality base stocks and excellent dispersants  
Blended with specific friction modifiers that are compatible with wet-clutches, suitable for JASO MA applications  
RL/42504 ... Full Synthetic 20W50 ... Case of 12 Quart (Twin cam Engine)



Your Harley wants better raw materials and more ZDDP than other brands offer.

### 20W50 MOTORCYCLE OIL

Designed for the latest Big-Twin motorcycle engines that specify 20W50 motor oil, including Evolution, Twin Cam and aftermarket engines of similar design  
Superior film strength through the use of ester base stocks for protection and ring seal  
Extended drain intervals over other brands due to higher quality base stocks and excellent dispersants  
Blended with specific friction modifiers that are compatible with wet-clutches, suitable for JASO MA applications  
RL/12504 ... Motor Oil 20W50 ... Case of 12 Quart (Evo and aftermarket engine not full synthetic)  
RL/12505 ... Motor Oil 20W50 ... Case of 4 Gallons



Not for every bike, for wide clearances and extreme desert temps.

### 20W60 MOTORCYCLE OIL

Recommended for V-twins that need more viscosity due to operation in extremely hot climates  
Popular for Evos and Twin Cam engines with big bore kits, stroker kits or issues with valvetrain noise  
Specifically blended for air-cooled V-Twin engines with traditionally wide clearances like Knuckleheads, Shovelheads and Panheads engines  
Superior film strength through the use of ester base stocks for protection and ring seal  
Extended drain intervals over other brands due to higher quality base stocks and excellent dispersants  
RL/12604 ... Full Synthetic 20W60 ... Case of 12 Quarts (and V-Rod Engine)  
RL/12605 ... Full Synthetic 20W60 ... Case of 4 Gallons

Just like our famous Assembly Lube, but a bit easier to get into tough spots.

### LIQUID ASSEMBLY LUBE

New, convenient version of the chemistry used in our popular paste sold in tubs  
Prevents metal contact and wear before adequate lubrication can be supplied  
Unlike other assembly lubes, this product will not plug filters after initial engine start-up  
Provides 3x greater film strength than conventional black Molybdenum Disulfide greases  
Excellent rust and corrosion inhibitor, allowing for long-term storage of parts and internal engine components  
Not for use on exhaust bolts or other fasteners associated with high temperature which require an anti-seize  
Recommended and used by top camshaft and drivetrain manufacturers  
RL/80319 ... Liquid Assembly Lube ... Case of 6 - 12OZ (355ml) (For any engine or transmission assembly)





# RED LINE



Everyone thinks about the transmission side, but the clutch and primary chain need love, too.

### V-TWIN PRIMARY CASE OIL

For 1984-to-present V-Twin American motorcycle engines, including Evolution, Twin Cam and aftermarket engines of similar design

Same fluid as our famous MTL gear oil

Improves clutch operation while reducing wear and temperature

Where most synthetics are too slippery for clutch operation, this friction-balanced product is balanced to provide less slip, smoother operation and helps to apply more power in modified engines

This product is for use in the primary chaincase with wet-diaphragm spring clutches

**RL/42904 ... V-Twin Primary oil ... Case of 12 Quart**

(For Noisy Primary , Twin Cam and Evo)



**Shockproof® technology to make a big impact against big impacts.**

### V-TWIN TRANSMISSION OIL WITH SHOCKPROOF®

This product dampens transmission noise (reducing the notorious shifting clunk found in these gearboxes), dramatically reduces temperature, provides thicker oil films between gear teeth and resists throw-off

For all aftermarket versions like Baker, JIMS, S&S, etc.

For all H-D® trans including with Evolution engines, Twin Cam engines and latest 6-speed Cruise Drive

Same fluid as our unique Heavy ShockProof® Gear Oil

**RL/42804 ... V-Twin Primary oil with Shockproof ... Case of 12 Quart**

Pre-mixed coolant for motorcycles is convenient and accurate. We rule at it.

### SUPERCOOL WITH WATERWETTER®

Convenient, pre-mixed coolant for motorcycles, ATVs, karts etc. - pour and go

Blended with purified, deionized water and proper WaterWetter percentage

**RL/80205 ... Super cool with Waterwetter ... Case of 4 1/2 Gallon**

(Coolant for Twin cam Twin cooled engines )



When was the last time you cleaned the carb on your motorcycle? Thought so.

### COMPLETE FUEL SYSTEM CLEANER - POWERSPORTS

Improves fuel economy, throttle response, hesitation and stalling

Pour one bottle into a street bike, dirt bike, ATV or PWC for quick clean-up

**RL/60102 ... Complete Fuel system cleaner ... Case of 12 Ounce 133ml**

(Fuel injected bikes )

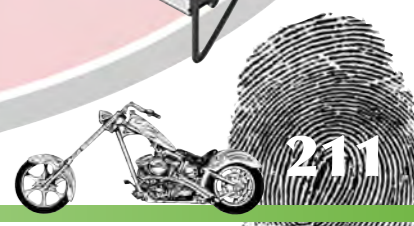
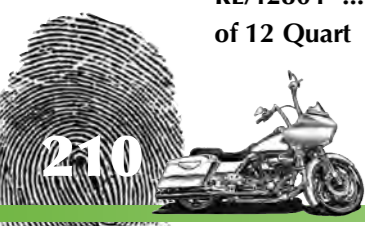



RR REDTHUNDER EXHAUST



# RR REDTHUNDER



*Our exhaust system has demonstrably enabled a 10% increased power combined with up to 50% lighter than standard model system weight. And that's not the only reason to switch to Red Thunder, because we only use stainless steel and lightweight materials our equipment stays rust-free, giving you a lifetime of high performance. Red Thunder was founded in 2014 in Italy and has been conquering the world ever since. All exhaust systems conform to the European regulations and are delivered with e-Mark certification.*





# RED THUNDER



Red Thunder brings together everything that is technically possible in our time. With the most modern techniques, untamed passion and countless hours on the dyno, we've created the most efficient Harley exhaust system in the world. Every system consists of three parts, which can be individually combined: three different finishes, three end caps and a removable DB killer. The easy installation of the entire system and the ability to effortlessly switch out individual parts is unbeatable.



**RR REDTHUNDER EXHAUST**



**RR REDTHUNDER EXHAUST**

<b>RT/74020DYS</b>	DYNA FULL 2in1 1991-2005 Satin
<b>RT/74020DYB</b>	DYNA FULL 2in1 1991-2005 Ceramic Black
<b>RT/74020DYPP</b>	DYNA FULL 2in1 1991-2005 Chrome
<b>RT/74007DYS</b>	DYNA FULL 2in1 2006 up Satin
<b>RT/74007DYB</b>	DYNA FULL 2in1 2006 up Ceramic Black
<b>RT/74007DYPP</b>	DYNA FULL 2in1 2006 up Chrome
<b>RT/74016DYS</b>	DYNA Slip On New Low Rider 2014 Satin
<b>RT/74016DYB</b>	DYNA Slip On New Low Rider 2014 Ceramic Black
<b>RT/74016DYPP</b>	DYNA Slip On New Low Rider 2014 Chrome

<b>RT/74014STB</b>	STREET 750 FULL 2in1 Ceramic Black
<b>RT/74015STB</b>	STREET 750 FULL Slip On Ceramic Black
<b>RT/74015STPP</b>	Slip on Street 750 chrome
<b>RT/74021SPS</b>	SPORTSTER FULL 2in1 2004 up Satin
<b>RT/74021SPB</b>	SPORTSTER FULL 2in1 2004 up Ceramic Black
<b>RT/74021SPPP</b>	SPORTSTER FULL 2in1 2004 up Chrome

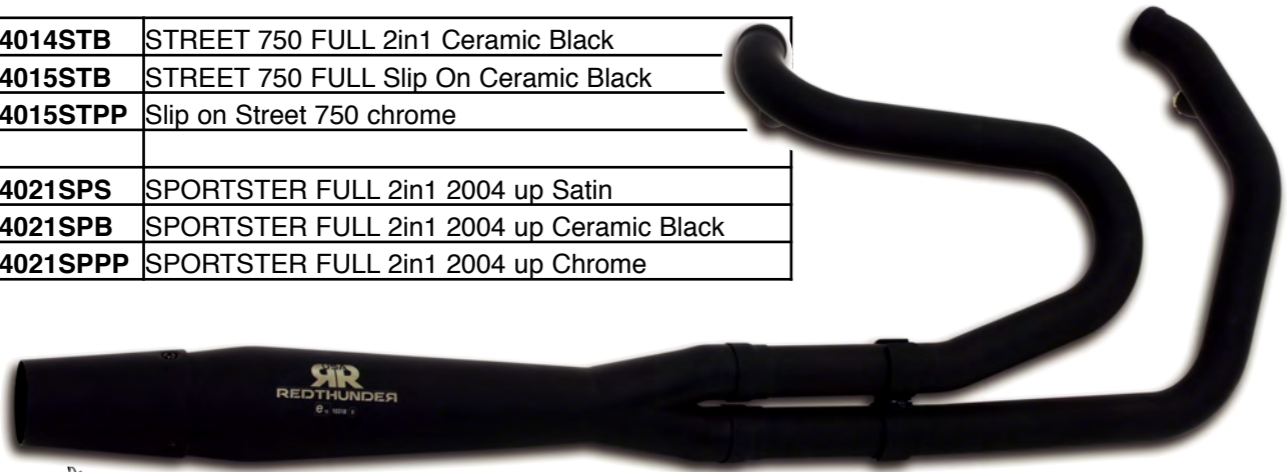

<b>RT/74024FXR</b>	FXR FULL 2in1 2005 up Titanium
<b>RT/74025DYT</b>	DYNA FULL 2in1 5 Speed Titanium





**RR REDTHUNDER EXHAUST**



<b>RT/74017SOS</b>	SOFTAIL FULL 2in1 1986 up Satin
<b>RT/74017SOB</b>	SOFTAIL FULL 2in1 1986 up Ceramic Black
<b>RT/74017SOPP</b>	SOFTAIL FULL 2in1 1986 up Chrome
<b>RT/74022SOS</b>	SOFTAIL BREAKOUT FULL 2in1 Satin
<b>RT/74022SOB</b>	SOFTAIL BREAKOUT FULL 2in1 Black
<b>RT/74022SOPP</b>	SOFTAIL BREAKOUT FULL 2in1 Chrome
<b>RT/74027SOS</b>	Softail 2018 Street/Fatbob/Fatboy 2in1 Polished
<b>RT/74027SOB</b>	Softail 2018 Street/Fatbob/Fatboy 2in1 Black

**Softail Fat Bob 2018**  
 Red Thunder propose this pair of slip on  
 for your Softail Fat Bob M8  
**RT/74028SOS** ... Fat Bob 2018up Slip on Satin  
**RT/74028SOB** ... Fat Bob 2018up Slip on Black  
**RT/74028SOPP** ... Fat Bob 2018up Slip on Chrome

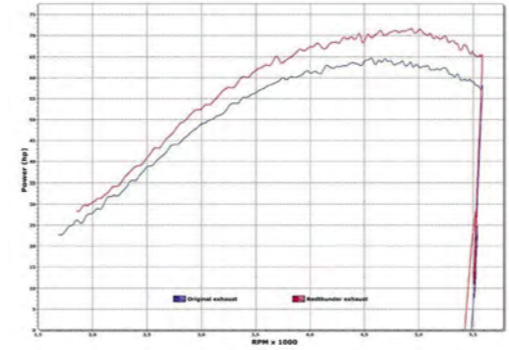

<b>RT/74008TOS</b>	TOURNING Dual Slip Ons 1999 up Satin
<b>RT/74008TOB</b>	TOURNING Dual Slip Ons 1999 up Ceramic Black
<b>RT/74008TOPP</b>	TOURNING Dual Slip Ons 1999 up Chrome
<b>RT/74011TOS</b>	TOURING FULL 2in1 99 - 2008 Satin
<b>RT/74011TOB</b>	TOURING FULL 2in1 99 - 2008 Ceramic Black
<b>RT/74011TOPP</b>	TOURING FULL 2in1 99 - 2008 Chrome
<b>RT/74010TOS</b>	TOURING FULL 2in1 2009 up Satin
<b>RT/74010TOB</b>	TOURING FULL 2in1 2009 up Ceramic Black
<b>RT/74010TOPP</b>	TOURING FULL 2in1 2009 up Chrome
<b>RT/74009TOS</b>	TOURING FULL 2in2 2009 up Satin
<b>RT/74009TOB</b>	TOURING FULL 2in2 2009 up Ceramic Black
<b>RT/74009TOPP</b>	TOURING FULL 2in2 2009 up Chrome



<b>RT/74023INB</b>	Indian Scout Dual Slipons Ceramic Black
<b>RT/74023INS</b>	Indian Scout Dual Slipons Satin
<b>RT/74023INP</b>	Indian Scout Dual Slipons Chrome



End Caps available for your Red Thunder Exhausts





# RICK'S<sup>®</sup> MOTORCYCLES



*Customizing from mild to wild  
Since about a quarter of a century Rick's Motorcycles is engaged with making custom parts  
and customizing individual stock motorcycles. This makes the company not only one of the oldest  
Harley-Davidson customizers in Europe, but also its enormous amount of experience  
makes it a pledge of credibility.*

*Rick's Motorcycles has always stood for maximum quality and unusual designs,  
Innovative parts for demanding customizing projects are being developed  
in Baden-Baden, fabrication is no secret but well known beyond the local area*



**RICK'S<sup>®</sup>**  
MOTORCYCLES

<http://ricks-motorcycles.com/en>



## Love me Fender! Rick's wheel covers for 2018 Softails

*If it's about fenders and rear conversions, Rick's is always the right choice.*

The German customizers been asleep during the last few months and are now able to present the first custom bikes on which many parts have been used that were developed especially for the new Milwaukee-Eight Softails, including of course different steel wheel covers. The bolt-on rear fender kits for Fat Boy and Breakout are available in three sizes: in 8" for the original rim with 240 tires, in 8" with original rim and 260 Metzeler tires and in 9" with 260 Metzeler tires. The variations for Breakout and Fat Boy are also offered as a complete kit with seat base plate, tank cover and mounting kit at a special price, compared to the individual items.

For the new Slim, Heritage and Deluxe suitable rear tire covers are also available. These are for rims up to 6" and 200 size tires.

A matching seat base plate is available as an option. For all new Softails also new and shapely front fenders were developed.

For the Fat Boy a steel fender with a massive Bobber look was constructed, which perfectly hugs the 160/60 18".

For Slim, Heritage and Deluxe a short steel cover in Old School look was formed, which follows the curves of the Metzeler 130/90 16".

There is, of course, also a suitable front wheel cover for the new Breakout in the program, which was matched to the tire contours of the OEM Michelin 130/60 21", but the Metzeler 120/70 with 21" is also covered perfectly. All front fenders are formed from 2.5 mm steel sheets, suitable for further processing and extremely resistant to twisting.



Licence Plate Side Bracket with LED including the new Softail 2018 Chrome or Gloss Black



Breakout 2018

Complete rear kit for all Softails including the 2018 models



Slim Deuce 2018



FatBoy 2018

Front fenders for all Softails including the 2018 models



Softail 2018 Fender 16"



Breakout 2018 Fender 21"



FatBoy 2018 Fender 18"



Road King

Street Glide

Handlebars



Road Glide

Grips



Adjustable Levers



Risers



Forks in 0° or 3° 3D Design From -4" to +12" Hard chrome With or without ABS Available in polished or Black anodized



Sporty Race Fender



Sportster pulley cover





# RICK'S MOTORCYCLES



Softail Gas Tank



Touring Gas Tank

### Swingarms

We have swingarms for  
Sportster up to 240  
Dynas up to 260  
Softail up to 260  
Fat Ass Kit Softail up to 360  
V-Rod up to 330



Mono Arm V-Rod



Sportster Swingarm



Dyna Swingarm



Fat Ass Kit Softail  
Trick N Roll



Rear Fender Kit  
for V-Rod



Rodder Design

Several Wheel Design ... in 1 piece or 3 pieces  
available either polished or RAL powder coated

Erbacher Design



Seven Sirs Design



Apollo Design



Super Steve



222



<http://ricks-motorcycles.com/en>



Rick Rod Design



223



# RIDE WRIGHT WHEELS



*"As we approach 20 years of designing, developing and producing the worlds finest Spoked Motorcycle Wheels, we reflect on what we've accomplished but more than that, we recognize that it's You that has pushed us to go above and beyond,*

*You that has set the trends,*

*You that has made us the greatest at what we do.*

*We are the RideWrights and our mission is to provide You with the best damn Spoked Motorcycle Wheels in the world, and for that, we thank You!*

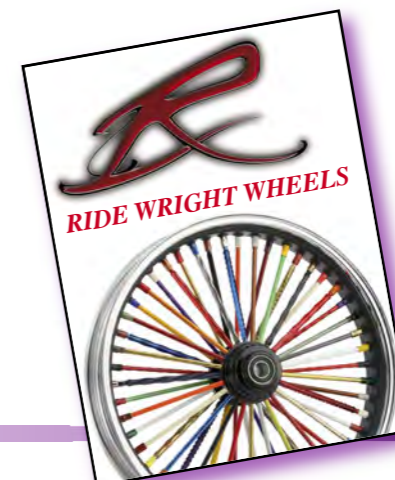



# YOU IMAGINE, WE CREATE



No matter what Size, Color, Spoke Style, or Custom Finish you want, we do it. Whatever year, make or model of Motorcycle you may have, we offer it.

Simple as that.

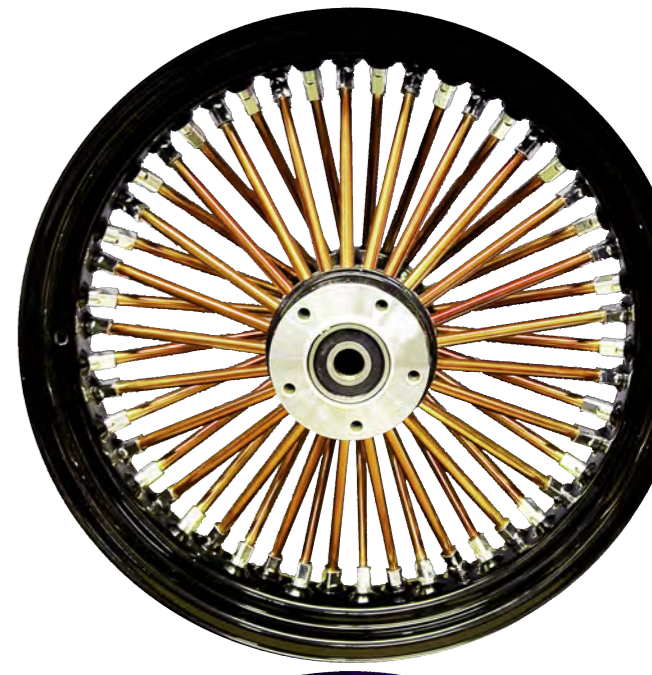

Pride, honor and undisputed quality. Hand crafted in the USA since 1999.





# Fat 50's

# Fat 30's

We've made easier to get the wheels you want!

Our All New Fat 30 is  
The Spoked Wheel to Have !  
Strong, Light, Stunning  
and available exclusively from us !



YOU IMAGINE, WE CREATE

No matter what Size, Color, Spoke Style,  
or Custom Finish you want, we do it.  
Whatever year, make or model of  
Motorcycle you may have, we offer it.

Simple as that.



Pride, honor and undisputed quality.  
Hand crafted in the USA since 1999.

Pride, honor and undisputed quality.  
Hand crafted in the USA since 1999.



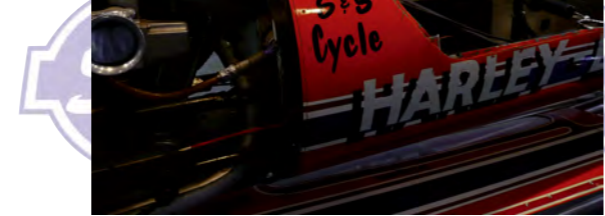
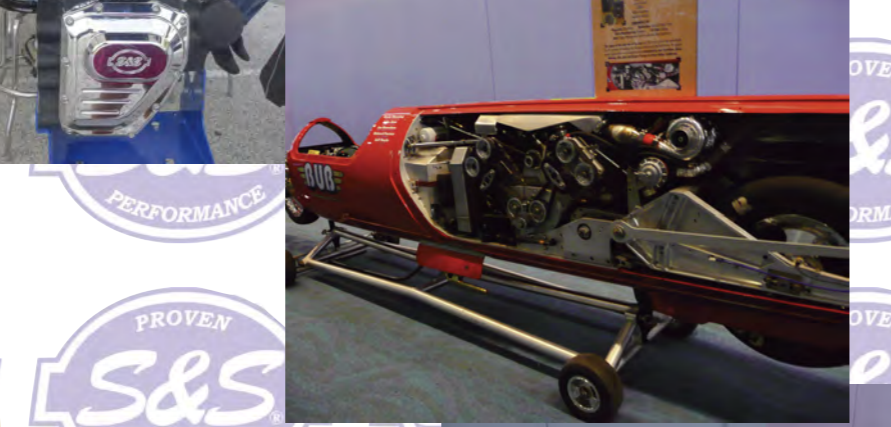

The company founded in 1958 has grown as the major name when it comes to performance in the V-twin aftermarket industry. S&S Cycle develops performance replacement engines and parts for V-Twin motorcycles manufactured in the United States with the custom motorcycle builder in mind. From innovations to track records the company has built such a knowledge that no serious performance builds can be started without parts selected from the impressive range of their offer. Making a stock engine more reliable is also possible using their trusted oem replacements made in the USA. Special orders fill the demand of performance engine builders with special requirements for their project. Whatever you need to fill your need for speed is on hand at S&S.



Racing Catalog







# S & S CYCLE



S&S parts can be found in most of the distributors catalogs but none of these offers the whole range of their great products. Mag can get you all their line from the smallest screw sold each to a complete special ordered engine tailored to your needs. That's where the purpose of Mag is to bring you the best and the most unobtainable bits to build the coolest engines and bikes.



**P-Series engines from S&S**  
In the fall of 2007, S&S introduced an engine with a retro look, but with updated technology. The Panhead engine has been hailed as the coolest looking classic engine of all time, and the P-Series engines from S&S capture that retro styling from the 50's and 60's, but with 21st century engineering. Keep in mind that as cool as these motors look, they are not reproductions. These engines were built to run!



**Special application cases - Designed for high performance engines with cylinder bores between 4" and 4 3/8".**

Fits 1984-'99 big twins with 4" bore and over  
Cam chest moved outward .250" to allow crankcases to handle large cylinder bore sizes  
Relocated cam chest oil pick-up increases gear case scavenging and virtually eliminates oil carry-over at sustained high speeds  
Machined to accept the stock oil filter assembly used on 1992-'99 big twins  
A ported breather passageway and a machined breather window allows the air/oil mist to flow from the flywheel cavity to the cam chest with the least possible restriction  
Crankcase venting can be achieved via two crankcase breathers, the cylinder heads, or both!  
We recommend using both crankcase breathers in engines larger than 95"  
Clearanced for strokes as long as 5"  
Machined for installation of a crank position sensor. This allows the cases to be used in EFI applications and also allows easy installation of S&S IST® Ignition and VFI Fuel Injection.  
A plug kit is included for applications that do not use a crank position sensor



**Hydraulic Valve Train Conversion Kit for Shovelhead Engines**  
Fits 1966-'84 HD® Big Twins. Convert any shovelhead engine to a quiet, dependable 1984-'99 style hydraulic valve train. Special polished billet tappet guides allow the use of late style tappets (included) and 1984-'99 style cams. S&S® Quickee pushrods can be installed quickly and easily. Top end oil can be fed through the pushrods if the engine is equipped with S&S® roller rocker arms, or through the stock external oil line if using stock style rocker arms (Order the appropriate kit).

**84" 86" or 88" 3-7/16" Bore Cylinder and Stroker Piston Kit for 1966-'84 HD® Big Twins**

This 3-7/16" bore cylinder and piston kit can be used to build 84", 86", or 88" stroker engines, or to replace the cylinders and piston in an engine with an existing S&S® stock bore stroker kit. Kit includes S&S 3-7/16" bore high tensile cast iron cylinders, 3-7/16" bore forged stroker pistons with rings and wristpins, head gaskets, S&S stainless steel head bolts with washers, base nuts, base gaskets. This kit can be used in engines with 4-1/2", 4-5/8" or 4-3/4" stroke flywheels.  
4-1/2" Stroke - 84" - 8.4:1 Compression  
4-5/8" Stroke - 86" - 9.4:1 Compression  
4-3/4" Stroke - 88" - 10.8:1 Compression



**106" Forged Stroker Pistons for 1999-'16 HD® Big Twins**  
These forged 3-7/8" bore stroker pistons for 1999-'16 HD® big twin are required for the S&S 106" stock bore stroker kit with 4-1/2" stroke flywheels. They are compatible with stock or S&S® Super Stock® cylinder heads. Stock 88" cylinders may be bored to fit these pistons, or S&S has replacement cylinders available.



**S&S oil line kit**  
The new S&S oil line kit includes a special transmission oil pan and stainless steel hard lines that make hook-up Allows the installation of a specially machined engine or crankcase into a late models Dyna Chassis  
New oil pan that includes new oil line routing.  
Oil pick-up tube routed to the rear of the oil pan for extended high acceleration (or wheelies)  
Stainless Hard oil lines

**Pistons For 2007-'17 S&S 103" Hot Set Up Kit**  
3-7/8" Bore For 103" Engines. S&S 3-7/8" pistons for 103" kits are machined to such close tolerances that it is not necessary to measure the piston. Additionally, the low friction coating on the piston skirt makes taking measurements very difficult. Therefore, hone cylinders to nominal diameter +/- 0.0001" for correct clearance.

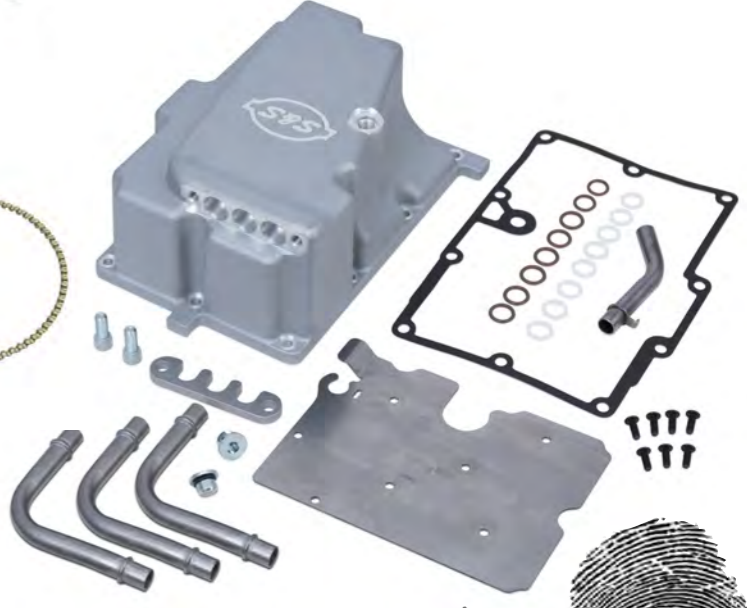

**Rocker Arm Rebuild Kit for 1966-'84 HD® Big Twins**  
Rebuild Kit for S&S® Roller Rocker Arms. Rebuilds four rocker arms..

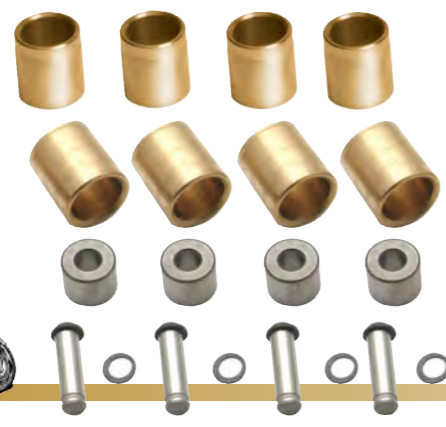



### MGAL and GAL series carburetors master rebuild kit

Fits MGAL and GAL carbs. Includes a body rebuild kit, all new fasteners, springs, idle mixture screw, seat, and needle assembly

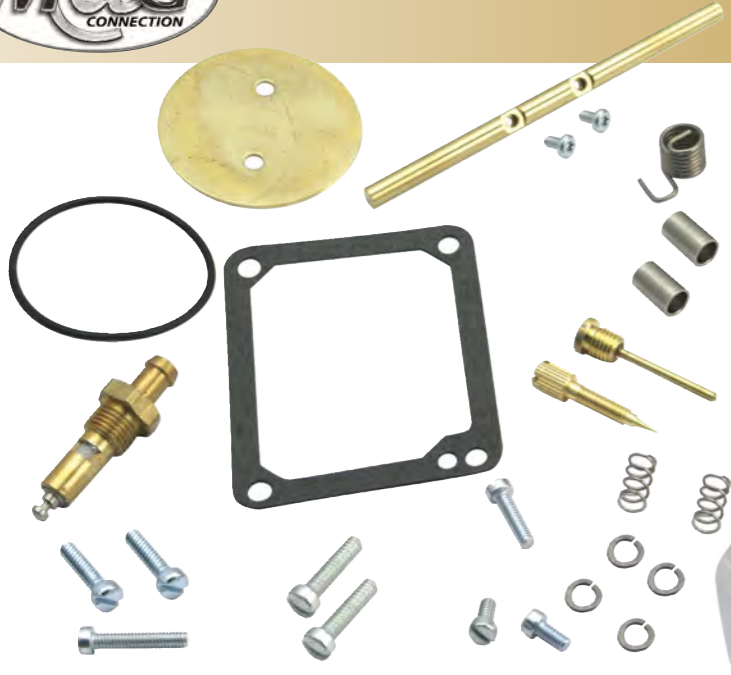

Replacement Polished Billet Oil Pump body



**Oil pump drive gear**  
Hard to find replacement oil pump drive gear for 1977 - '87 Sportster models. Can be used for stock replacement and is required for use with S&S pinion shafts used in S&S flywheel assemblies for all 1986-'03 Sportster models. These are splined style pinion shafts, experience has shown that the keyed design is not as strong, and that the splined pinion shafts are preferable for high performance applications.  
Replaces 26318-75.



### Boring Plate kit

This boring plate kit is designed for boring stock crankcases of Harley-Davidson Twin Cam 88 engines to accept S&S Super Sidewinder 4 and 4-1/8 inch bore cylinders. A spacer is included with the kit which allows the cases to be bored without removing the cylinder studs. Kit includes: Boring plate 3-3/4 inch, tall spacer.

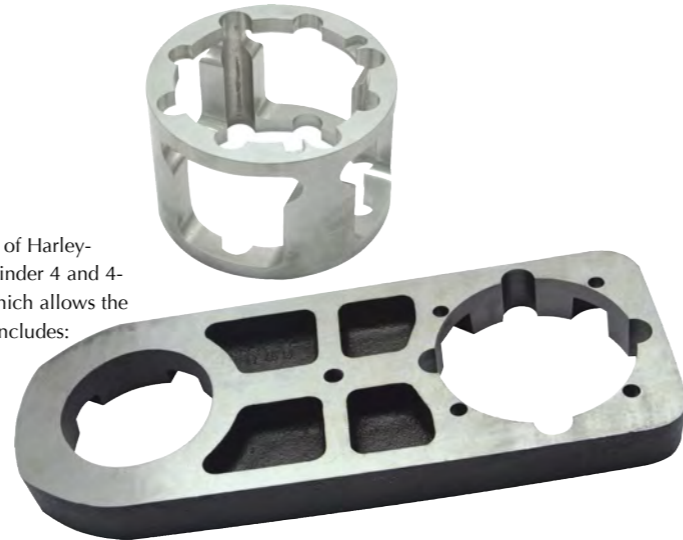

### Kick Start Cover

transmission kick start cover kit with the correct finish and cast texture to replace early four speed cover when a stock look is required.



### Teardrop Cover

S&S Gloss Black Mini Teardrop Stealth Air Cleaner Cover  
We shrank the S&S Cycle Teardrop shape to the perfect proportions and laid it over our easy to install

### S&S Super Stock Ignition Kit for HD Evolution 100", 107", and 113" 1984-'99

Modules can be set to kick-start or electric-start mode by an S&S dealer using the Super Stock diagnostic cable and software  
Electric-start mode allows the pre-ignition cranking to be set anywhere from 1 to 4 engine revolutions (only available with current modules - earlier modules cannot be updated)  
Pre-programmed ignitions are custom tailored for a specific S&S engine - no need for adjustments  
Single fire operation - requires a single fire coil for single spark plug applications  
Dual plugged applications require a pair of two tower coils or a single four tower coil  
Minimum 3.0 ohms primary resistance  
Overload and short circuit protected  
VOES switches to less aggressive curve under load or hard acceleration  
6300 rpm rev-limiter  
24-hour break-in rev-limiter - prevents damage during break-in  
Data logging diagnostic capabilities  
Fits 1984-'99 Harley-Davidson big twin models with 113" V-Series engines. S&S Super Stock ignition systems are available in complete ignition kits and as replacement modules. S&S single fire ignition coils are available separately.  
NOTE:  
Keep in mind that the curves are preset for a specific S&S engine, and that modules intended for one engine may not yield optimum results when used on another configuration.  
Application Module Ignition Kit :  
S&S 80" Alternator/Generator shovelhead ... **SS/55-1350**  
S&S 93" Alternator/Generator shovelhead ... **SS/55-1351**  
S&S 93" HC Alternator/Generator shovelhead ... **SS/55-1352**  
S&S 96" V96 ... **SS/55-1354**  
S&S 113" V113 ... **SS/55-1355**  
S&S 124" V124 ... **SS/55-1356**



### Stage II, Kit, Grand National mufflers, 509G for 99-06 BT

Bolt In Cams, 509G  
Premium Tappets  
Quicke Pushrods  
Grand National Slip Ons, Chrome  
Stealth Air Cleaner with Air 1 Cover



### Variable Pressure Clutch Plate

The S&S Variable Pressure Clutch Plate is the most cost effective kit for upgrading your H-D® stock clutch without any modifications. Up to 40% more pressure for stronger clutch engagement. It works like a lock up clutch with increased torque capacity: strength of engagement increases with RPM. Simple 10 minute installation. Fits behind a stock derby cover and primary cover - No modification required, and can be used with cable or hydraulic clutch controls.

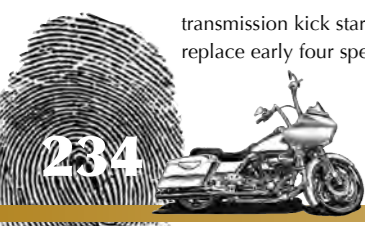

# storz Performance Inc.



*Great energy and new products every time with Storz Performance !  
 "Not forget to have fun with our two wheeled toys" could be the master mind of Storz Performance !  
 Motorcycle riding is a great therapy to struggle daily life stress  
 As always we're committed to providing you the highest quality components  
 at a fair price with top-notch service and technical support.  
 Real value is acquired in the purchase of high quality accessories  
 such as Storz/Ceriani front forks as well as our complete line of accessories  
 for the HD xr 1200 and other Sportster models.*





## STORZ DIRT TRACK STYLE CONVERSION - 1986 to 2003

Starting with any 883 or 1200 model Evolution Sportster (1986 - 2003) you can achieve the Dirt Track racer look shown here. Most of the components feature simple bolt-on installation and most items are also suitable for the 1983-84 XR1000.

The rear-set footpegs and dirt track seat give you a more aggressive riding stance and the beautifully hand formed aluminum alloy fuel tank offers a 2.75 gallon capacity. The 10" rear disc kit features a floating style bracket that transfers braking torque directly to the frame instead of the swingarm to decrease wheel hop under heavy braking. The front fender is a stock Sportster item.

Our Storz / Ceriani Black Satin 55mm Inverted Fork handles the suspension chores up front and Works Performance billet aluminum shocks suspend the rear.

All kit pieces are offered individually so you can build the bike as your budget allows.

"The Storz Performance XR883 blends the rugged styling of an XR750 dirt-track racer with the reliability of a stock Sportster... a nimble-handling, good-running, sweet-sounding honey of a motorcycle that just happens to look like it got lost on the way to the San Jose Mile." **Cycle World**



Dirt Track Style Seat with Saddlemen Pad



Dirt Track Style Alloy Gas Tank

Underseat tail light 1994 to 2003



10" Rear Disc Brake Kit



Rear Set Foot Pegs

## Start with a Sportster... Wind up with this.

Put some more sport in your Sportster! The stock Evo Sporty is a great bike with lots of potential. Finish it off with our Dirt Track Style conversion for great looks and performance.



Sun 18" Alloy Rims and Stainless Spokes



Storz / Ceriani Steering Damper Kits



Storz / Ceriani Forks

Braided Steel Brake Lines



238

239

## XR STYLE FIBERGLASS SEAT CONVERSIONS



Our hand laid fiberglass seats are supplied in gelcoat finish and include a special Saddlemen seat pads. Seat mounting kits and inner fender must be ordered separately. 1994-2009 Sportsters have underseat mounting of the license plate and tail light.

### FIBERGLASS SEATS WITH PAD

- FGL-150 Dirt Track Style 1986-2003
- IF-150 Inner fender for 1986-2003
- FGL-250 XR Style for Sportster 2004-2008 (Alloy tank)
- FGL-255 XR Style for Sportster 2004-2008 (Stock tank)
- IF-250 Inner fender for 2004-2006
- IF-255 Inner fender for 2007-2010

### SEAT MOUNTING KITS

- ML-051 Seat mounting kit for 1982-93 Sportster & XR1000
- ML-051-94 Seat mounting subframe kit for 1994-2003\* (includes tail light and stainless steel license plate holder)
- ML-051-04 Seat mounting subframe kit for 2004-2010 (includes tail light and stainless steel license plate holder)



2004-2010



1994-2003



1982-1993



2004-2010 with stock gas tank

\*NOTE: For 1994 and later Sportsters seat kits we recommend that the stock fender support rails be shortened. A template is included with instructions.

## STORZ REAR SET FOOTPEGS FOR SPORTSTERS



### Rear Set Kits for 2004 - 2010 (Except H-D XR1200) Rubber Mount Sportsters

Our beautifully machined billet aluminium rear set footpeg kits are available for 1986-2010 model 883, 1100, & 1200 Sportsters. These bolt-on kits relocate the footpegs to a more sporting rearward position which is comfortable without being too aggressive. The footpegs, levers, and mounting brackets are CNC machined from solid 6061-T6 aluminum. They are designed to bolt directly to existing holes in the stock primary cover, sprocket cover, or frame.

Our knurled aluminium footpegs feature leveling screws to compensate for wear and our footpeg pivots will also accept the standard H-D rubber covered passenger pegs. Complete instructions and hardware are included and no drilling is necessary for installation.

**NOTE:** Storz rear set footpeg kits are not compatible with the stock Sportster exhaust system. They require the use of an aftermarket exhaust such as a 2:1 low pipe or 2:2 high pipe which does not run across the sprocket cover.



2004-2009 left side, std. shift pattern for high or low pipe.



2004-2009 right side brake

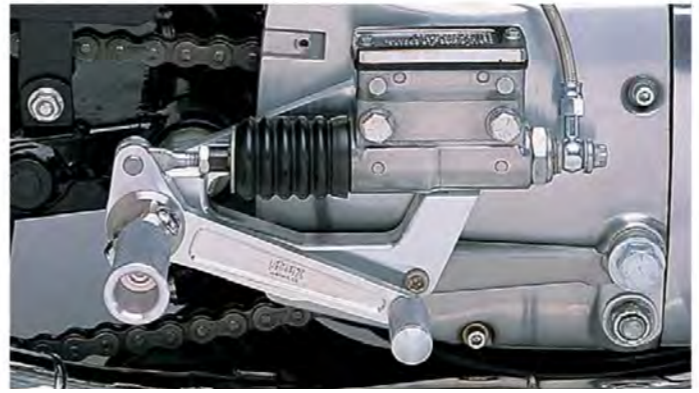

1994-2003 left side, std. shift pattern

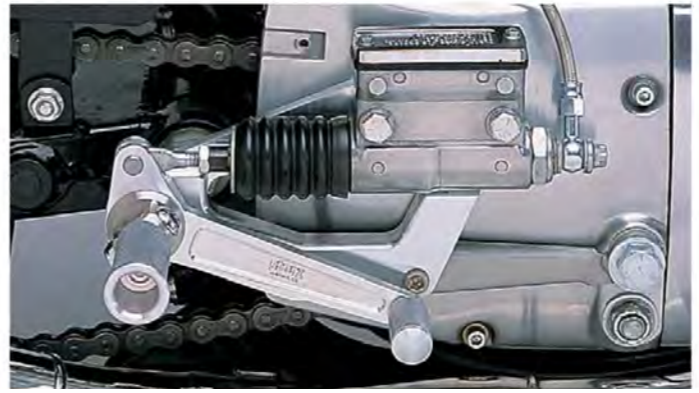

1991-2003 right side brake (low pipe)

All the parts from Storz Performance with MAG Connection Just ask for a quotation !





**SUPERTRAPP**

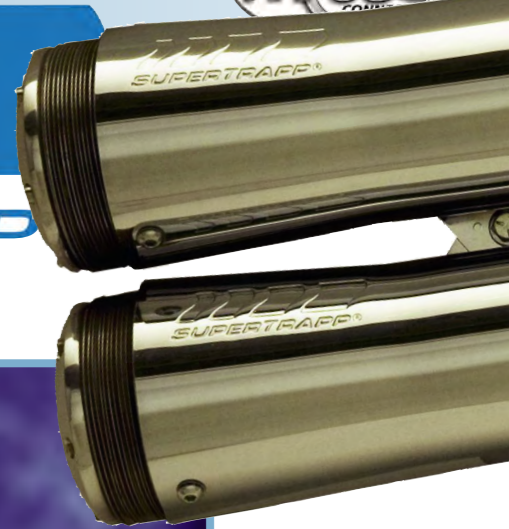

**SUPERTRAPP**

*The SuperTrapp muffler was born in the late 60's, SuperTrapp Industries, Inc. has grown to be a leading manufacturer of aftermarket performance exhaust systems for a variety of motor vehicle applications, including motorcycle, ATV and automotive. The SuperTrapp brand has long been recognized as the performance standard, combining added power with innovative styling, quality, and versatile sound. Based in Cleveland, Ohio, SuperTrapp manufactures a full line of branded aftermarket exhaust systems, the company also owns and manufactures the performance product brands Kerker, Jardine, Jay Brake and TPI Racing.*

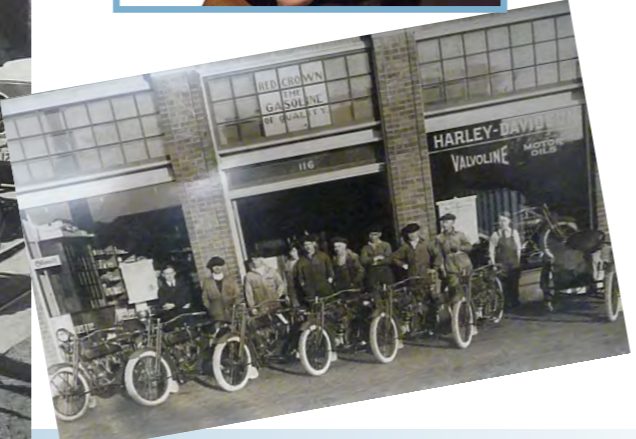

"Pipes can make or break you. The advantage of SuperTrapp is their tunable disc technology that makes it easier to find that sweet spot once the motor work is done. It ensures that you don't leave 10 to 15 HP under the table." Wes Brown, Leader of the performance machine that is Cycle-Rama. AMI Horsepower Shootout Winner Eight Years Running.

It's not about what you ride... It's about bringing life to your ride.

We are a family of motorcycle and power sport enthusiasts who design and manufacture Distinctive Performance Exhausts and Ride- Enhancing Products.

We exist to bring MORE LIFE to your Riding Experience.

Bringing more Life to your riding experience is not easy,

we do it through a unique combination of...

Personalized Distinctive "Sound"

Individual Tailored "Style"

Added On-Demand "Power"

...from passionate riders just like you!



**BootLegger 2:1 Systems**

- All stainless TIG welded design
- High flow stepped headpipe
- Adjustable turn out end cap standard
- Optional end caps available
- Compatible with extended bags



**FatShots 2:1**

for Baggers, Dynas and Softails is a versatile, tunable, disc-based, high performance exhaust system. The chrome-plated 2:1 headpipe features 1.75" diameter primary pipes which flow into a 2.5" diameter collector. They include full coverage bright chrome heatshields



**SuperTrapp Unfiltered 2:1:2 Bagger Headpipes 2017 up FLH Models**

- Tuned for performance
- Aggressive price
- Utilizes factory heatshields and crossover
- Compatible with popular SuperTrapp and Kerker performance Slip-Ons
- Reduced heat vs stock headpipe
- Substantially outflows the factory unit
- Has 12mm O2 ports for factory O2 sensor
- Chrome plated for durability

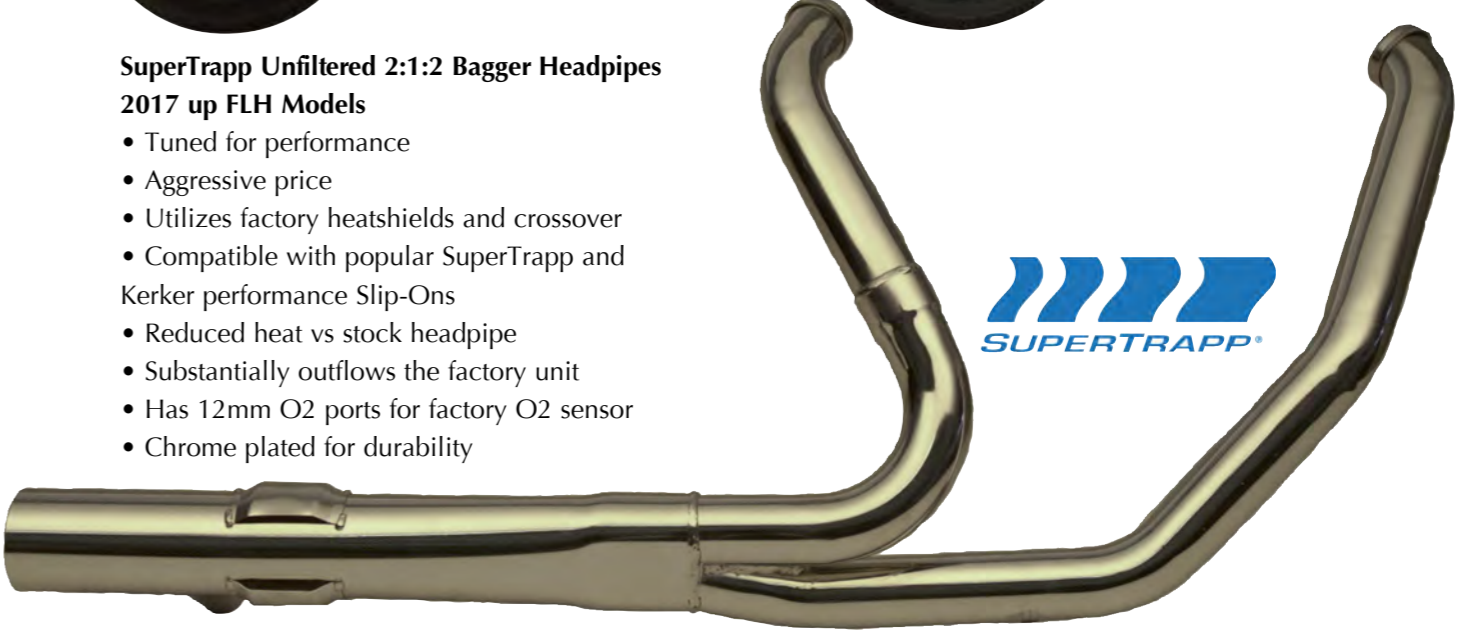

**Internal Disc Series Slip-Ons for Indian Scout**

- Significant increase in exhaust flow
- Tunable, 3" internal disc-based Slip-On mufflers
- Chrome-plated 3.5" diameter muffler bodies
- Supplied with chrome-plated removable tapered end caps
- Features a rebuildable core
- Fits '15 - '16 Indian Scout



### SuperTrapp 2:1 SuperMegs

are the notorious exhaust upgrade with proven out-of-the-box 15% bolt-on horsepower gains across the board and a respectable sound. Available for Baggers, Softails, Dynas, Sportsters and 230 and 250 Wide Tire Customs.

This system utilizes our patented Tunable Disc Technology

The 2.5" collector allows maximum flow for even the largest big bore motors. Three piece heat shields keep the blues away.

Available in show quality Chrome or Black. The black 2:1 features black chrome head pipes and black ceramic coated heat shields and muffler body. Rebuildable core and packing.



### Jardine Backrest

Patented system that makes for quick and easy backrest installation or removal within seconds. Clean lines, ease of use and quality workmanship. Universal Backrests available in: Tall Billet, Short Billet, Billet Touring, Short Steel and Mini Steel. Easy to install.



Tall Billet  
P/N 32-0001-01



Short Billet  
P/N 32-0002-01



Touring Billet  
P/N 32-0003-01



Short Steel  
P/N 32-0004-01



Mini Steel  
P/N 32-0005-01



Touring Steel  
P/N 32-0007-01



All of



## Jardine

PERFORMANCE PRODUCTS

# JAYBRAKE



### Jay Brake Forward Controls

Fully adjustable pegs and brake / shift lever to allow for the perfect fit. Sold in sets. Constructed of steel and billet aluminum. Utilizes stock mounts and master cylinder. Fits 2000 & up Softails. Requires

a 2000 - 2006 Softail-style kickstand. Peg Adapter is compatible with H-D style peg mounts. Peg Adapter Kits come with H-D-style foot peg clevis adapters and shift / brake pedal adapters having 5/16"-24 threads. Available in chrome / black or black.

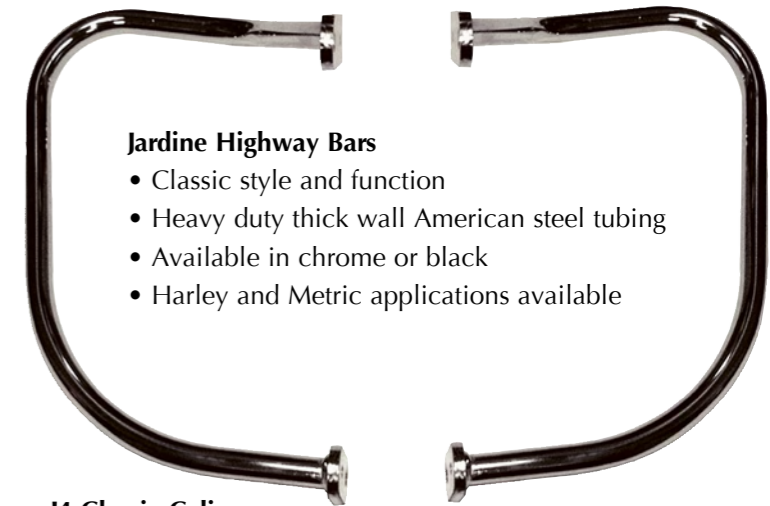

### Jardine Highway Bars

- Classic style and function
- Heavy duty thick wall American steel tubing
- Available in chrome or black
- Harley and Metric applications available

### J4 Classic Calipers

A progressively sized four piston billet aluminum caliper. Direct bolt on to stock H-D '84 - '99 front legs with 11.5" rotors (except Springers). Brackets needed for use with the rear rotor. Right or left side fit in a smooth or radial design. Comes w/ banjo bolt J-300-8. Available in polished aluminum, chrome or black.



Wide band

Multi-band

Dovetail

Full Rubber

Ultra

Extreme

Factor



### Universal Megaphone Series

4" disc-based Slip-On are available in Straight Cut Satin or Polished Stainless Steel 19" length cone body (17.5" cone + 1.5" inlet).

The classic Megaphone design allows the exhaust gas to expand which increases power. Optional Open End Caps for closed course competition are also available.

They utilize the patented Tunable Disc Technology.







# TC Bros.

TC Bros

TC Bros

TC Bros



Founded in 2006 by two brothers from Ohio with a passion for garage built custom motorcycles, TC Bros. has become a leading supplier for the do-it-yourself custom bike builder.

Our motto, *Engineered for Freedom* symbolizes the passion we put into our products as well as the freedom experienced on 2 wheels.

Our high quality products and fast, friendly service means you spend less time waiting and more time riding. Thank you to our past, present, and future customers for all of your support!

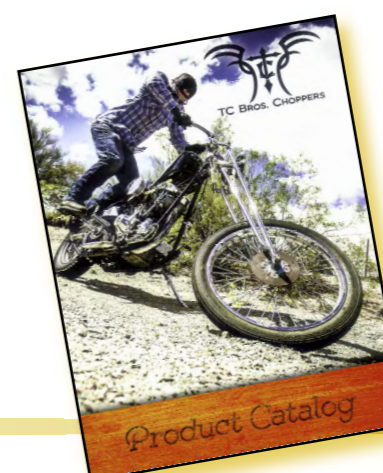



# TC BROS



### 1" Handlebars ... but also 7/8"

All are 100% Tig Welded and available in Chrome or Black finition and smooth (non-dimpled) or Dimpled for 82up HD applications  
14 Models to discover with TC Bros Choppers. Some 7/8" handlabers available too like the Slane Splitter, Apesin 120 & 15", Drag Bars.



### Hardtails

Precision CNC Mandrel Bent tubing.  
Welded in a precicion CNC Machined Fixture for the best fit in the industry.  
Easy to follow instructions



TC Bros. Choppers bolt on mid controls kit fit all 883 and 1200 models of Harley Davidson Sportster 5 speed from 1991-2003. Kit features CNC machined 6061 aluminum folding footpegs with a knurled, non slip finish for great looks and performance. Heavy duty steel mounting brackets are TIG welded and powdercoated satin black for a highly durable finish. Highly detailed mounting instructions are included for easy installation. Kit includes everything you need to bolt these to your Sportster, whether it came with factory mid controls or factory forward controls. All pivot points utilize oil impregnated, precision fit bronze bushings for long life. Foot position is the same as a set of OEM Harley mid controls for an all around, comfortable ride. Proudly made in the USA!

**TCB/102-0077**  
Sportster Mid Controls Kit for 91-03  
5 Speed by TC Bros Choppers

**TCB/102-0078**  
Sportster Mid Controls Kit (NO PEGS) for 91-03  
5 Speed by TC Bros Choppers



### TCB/109-0115

Get rid of your bulky "Ham-Can" style air cleaner and show off your V-Twin Engine with this TC Bros. chrome louvered air cleaner. Kit features CNC machined, powder coated steel mounting bracket that is proudly made in the USA. Included mounting hardware fits into recessed holes to provide proper sealing surface for included filter element. Kit includes both a hotrod inspired Tri-Bar wing bolt or standard round head screw hardware. This ultra-compact kit is designed to fit all Harley Davidson® Big Twin and Sportster models using factory CV Carburetors or factory electronic fuel injection (EFI) units. This kit will not fit 1995-2001 HD Big Twin models equipped with Magneti Marelli fuel injection units using dual bore throttle bodies. If installing on models using a CV carburetor, it is highly recommended to use in conjunction with a support bracket for longevity. See TC Bros. SKU #109-0083 for Sportster models. Support bracket is not required on EFI models. Note: EVO Big Twins and 1991-up Sportsters also require crankcase breathers. See TC Bros. SKU #109-0082.

### TCB/109-0116

This ultra-compact kit is designed to fit all Harley Davidson® Big Twin and Sportster models using S&S® Super E or Super G series carb only.



### Cast Air Cleaners

Beautifully hand cast from 356-T6 aluminum right here in the USA. Washable cotton gauze filter element provides high performance air flow to your V-Twin. Kit attaches easily using the American made, CNC machined, powder coated steel mounting bracket.



### TCB/109-0082

TC Bros. Breather Bolts For your 1991-UP Sportster & EVO Big Twin Harley Motors (does not fit Twin Cam models). These bolts are the cleanest way to solve your crankcase venting issues when installing aftermarket air cleaners on your Harley. They are fully CNC machined 6061 aluminum that is polished for a super clean look! They include stainless steel vent screens, stainless washers, circlips and foam filter elements. No more ugly hoses and bulky breather filters to deal with! MADE IN USA! These work great with TC Bros. Sportster Carburetor Support Bracket #109-0083 (not includ-

### TCB/109-0083

TC Bros. air cleaner/carb support bracket is a must when mounting aftermarket air filters to your stock CV type carburetors. Bracket fits 1991-2003 HD Sportster. Gasket Included. CNC laser cut steel bracket with durable black powdercoat finish. MADE IN USA! Work great with TC Bros. Breather Bolts #109-0082





# TC BROS



- TCB/113-0004 ... Springer Front End -2" Under Black fits Harley Davidson
- TCB/113-0005 ... Springer Front End -2" Under Chrome fits Harley Davidson
- TCB/113-0037 ... Springer Front End -4" Under Black fits Harley Davidson
- TCB/113-0038 ... Springer Front End -4" Under Chrome fits Harley Davidson
- TCB/113-0039 ... Springer Front End Stock Length Black fits Harley Davidson
- TCB/113-0040 ... Springer Front End Stock Length Chrome fits Harley Davidson



### Large Radius Sportster Exhaust Pipes fit 2004-2016 Black Finish TCB/109-0150

NEW SPORTSTER BLACK PIPES FOR 2004-2016 XL883 and XL1200  
These fit 2007 and newer ( because they have threaded holes for the exhaust sensors )  
They will also fit 2004-2006 (but you will have to purchase plugs for the sensor holes)

### Universal Ignition Switch

Universal Ignition Switch features a 3 Position switch with labeled terminals: (Off, On and Accessory) for easy hook-ups.  
Improved design has vibration resistant solid contacts unlike most other ignition switches that fail shortly after installed.  
Has a 3/4" Stem diameter, includes 2 keys.



### Colored Vintage cloth covered wire 25ft

Premium vintage style cloth covered 16GA wire. Sold in 25ft lengths. Perfect finishing touch for vintage chopper or cafe racer projects. Modern PVC inner insulation and stranded copper for maximum performance.



Choice of Hardtail Seats

### Choice of Vertical & Horizontal Plate holders with Taillight



Moto Iron™ brand, Chrome Stock Length Harley Springer Front End. Moto Iron™ has been successful in producing a high quality springer front end that is affordable to all bike builders. With its heavy duty, one piece forged rear legs and beefy 1" diameter front legs, these springers offer a high strength level of quality at a price that cannot be beaten. When viewing next to leading competitors, the differences were easy for us to see why they are the better choice. These Springers will fit most Harley Davidson Big Twins from 1949-Present and 1982-2003 Sportsters with 1" neck bearings. To use with 1952-1981 Sportsters, a 7/8" - 1" neck cup conversion kit will be needed. Please contact us for details. These are Designed to fit Harley frames, they have a 1" diameter stem, and use the included 3/4" diameter axle and spacers. The included spacers are designed to fit Harley Wide Glide wheels from 1984 - 1999. They work with a 11.5" Harley brake rotor (84-99), and Springer type brake caliper (see our other listings for these items). You can run other wheels (Narrow Glide, etc...) but you will need to cut your own wheel spacers in order to do so. The top tree accepts 1/2"-20 fine thread risers and the riser spacing is 4.75" center to center (same as OEM Harley Springers). Moto Iron™ springers do not fit 2004 & newer Harley Sportsters because of turning radius and fork lock interference.

### Triangle Chopper Headlight Aris Style



252



Black 33 Ford Replica Taillight



### Sparto Taillight



253

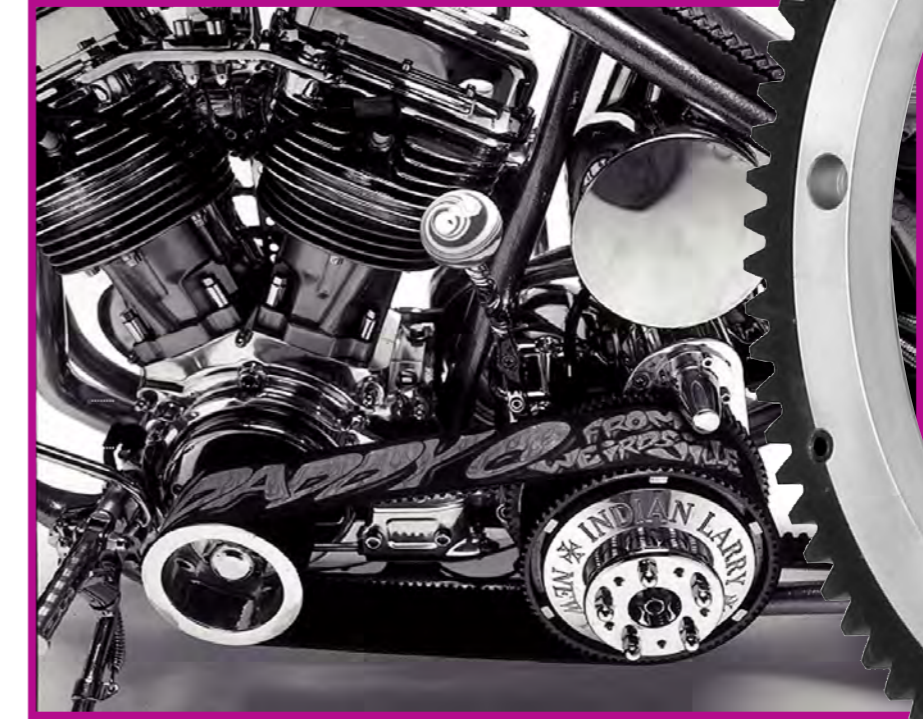

*Tech Cycle Performance Products, Inc. has been a pioneer in the motorcycle components field. Among the first products designed, engineered, and manufactured were 4-Speed and 5-Speed electric start conversion kits for open primary Harley-Davidson and V-Twin kick start motorcycles.*

*A complete line of engineered high torque, gear reduction starters for 1965-88 closed primary Harley-Davidson motorcycles followed shortly thereafter. Once in the marketplace, the industry embraced Tech and recognized their high performance gear reduction starters as the number one quality starter line for cranking big inch, high compression motors.*



## Tech Cycle Spirit and Product Line

Over the years, Tech has expanded its product lines to include a complete line of high styled open primary belt drive systems, and engine components. The product line is expansive beginning with 1936 Knucklehead / Panheads through Pan-Shovelheads, Shovelheads, Cowpies, Evo's, Twin Cams, continuing all the way to current Harley-Davidson® production. We have become standard equipment on many custom bike builder and OEM offerings. Tech continues to look to the future with great optimism, offering the motorcycle industry an ever expanding line of products engineered for excellence. Our mission is to remain the leading supplier of motorcycle starter solutions worldwide through product innovation, manufacturing consistency, and enhancement of customer productivity with product efficacy and service solutions.

Tech Cycle offers systems for Touring models (1990-2006) : Electra-Glides, Road Glide, Road Kings, Tour Glides, Screamin' Eagle and Street Glide; Softail models (1990-2006) : Custom, CVO, Deluxe, Springer, Standard, Deuce, Night Train, Bad Boy, Heritage and Fat Boy; and FXR / Dynas (1990-2006) : CVO's, Dyna Glides, Sturgis, Low Rider and Wide Glide. In 2006, Harley-Davidson redesigned their Dyna primaries and in 2007, Harley-Davidson adopted the same format for the Electra Glides and Softails. Thereafter, Tech Cycle has offered systems for the following FL models (2007-2016) : Tour Glide, Electro-Glides, Road Glide, Road Kings, Tour Glides Screamin' Eagle and Street Glide; Softail models (2007-2016) : CVO, Springer, Deuce, Night Train, Bad Boy, Heritage, Fat Boy and X-Bones; and Dynas (2006-2016) : Dyna Glides, Fat Bob, Sturgis, Low Rider and Wide Glide. We also have Rockers and Breakout kits.



5 Speed style Open primary chain drive



2" Belt Drive Kit w Polished



Flame Cover



Auto clutch

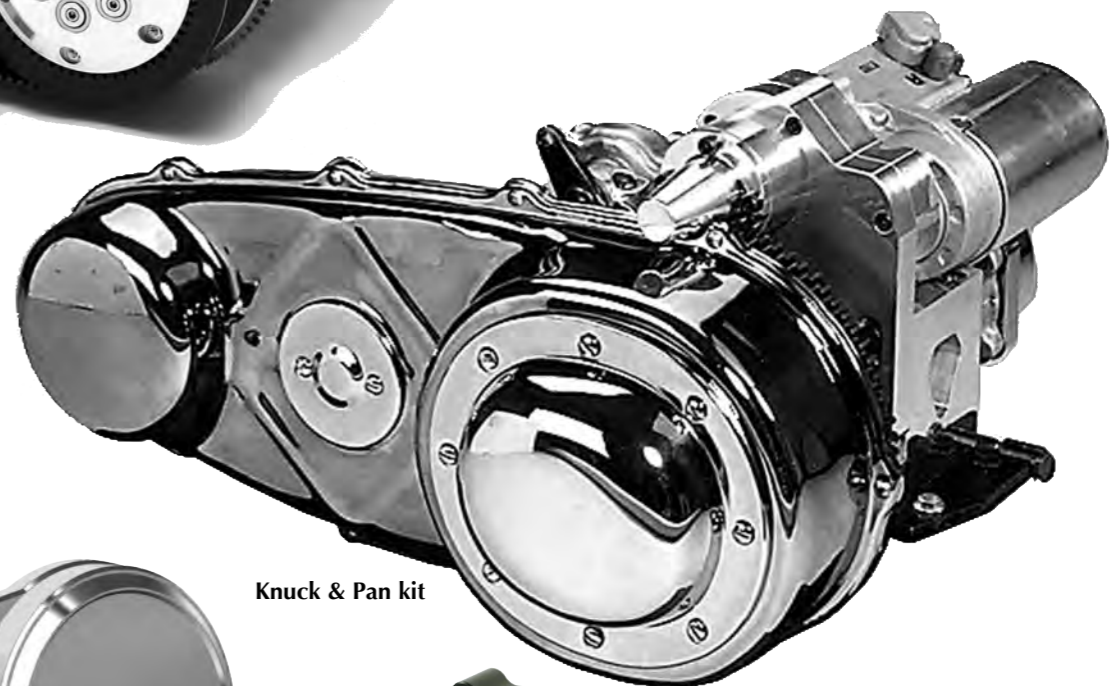

Knuck & Pan kit



2" Cyclone Belt drive kit with optional mid controls



2" Cyclone Belt Drive kit



Twister outboard bearing support system



Stealth Belt drive kit



Indian Larry Legacy hidden starter kit

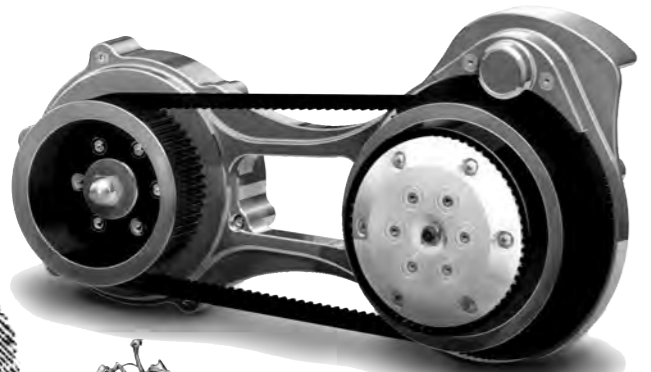

07-up models Contoured Cyclone kit

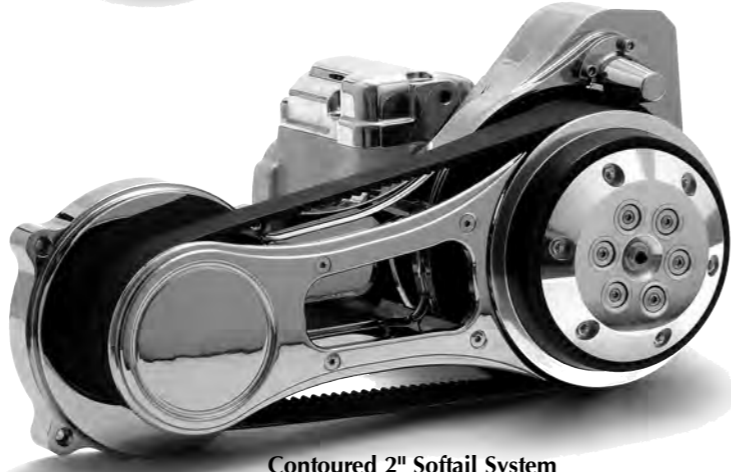

Contoured 2" Softail System with optional belt guard



Twister open primary belt drive system





# TECH CYCLE

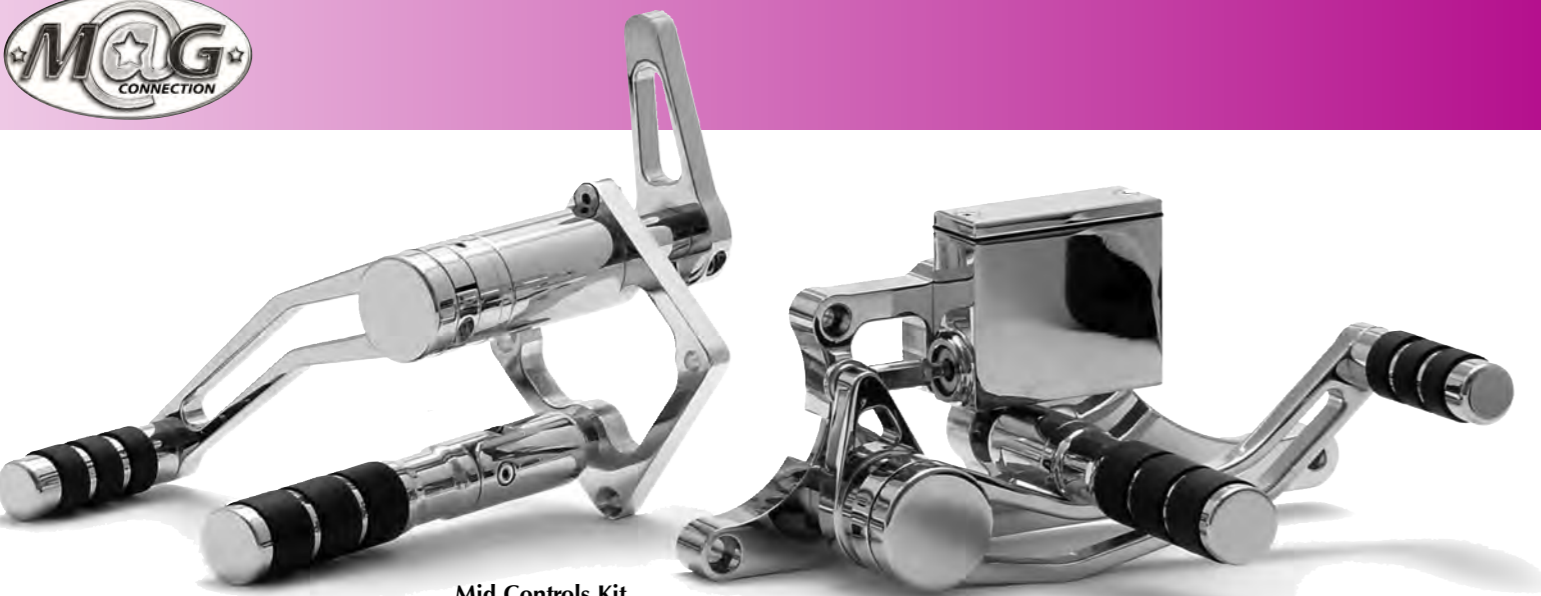

Mid Controls Kit



Starter



Starter kit



Drop in clutch



Auto clutch



Lockup complete

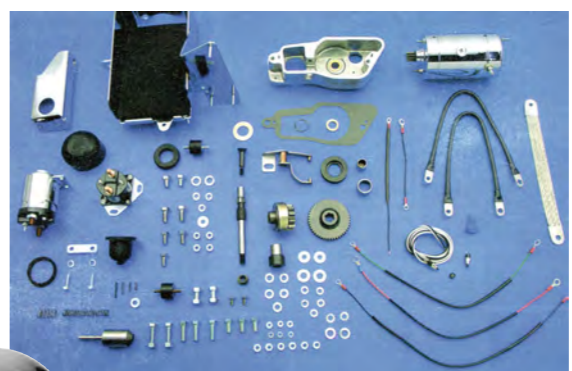

Go from this ..... to this !



Billet Compact Starter for 67-80 Sportster

## 10 REASONS WHY "NOTHING STARTS WITHOUT US!"

- 1. All Brand New Components** — Unlike our competitors, Tech Cycle uses no remanufactured parts in our starters. We refuse to sacrifice quality for cost savings.
- 2. Manufactured by Nippondenso** — All of our electrical components are manufactured by Nippondenso, the world's leading starter manufacturer. Many of our competitors choose to use Taiwanese starters that just won't do the job for the long haul.
- 3. Top Quality Bearings** — All bearings in our starters are manufactured in the U.S. or Japan. You won't find a Chinese or Taiwanese bearing in one of our starters like you will in many others.
- 4. Heavy Duty Clutch** — Our clutches are designed to withstand the beating of your big inch, high compression application. Simply put, you won't see the clutch failures with our starters that you've become accustomed to seeing in others.
- 5. High Quality Finish** — We offer a polished, chrome dipped finish on our starters. Many of our competitors have tried to pass off chrome tape on their starter motors as a "chrome finish."
- 6. High Performance** — Available in 1.4kW, 1.8kW, and 2.0kW sizes, our Tornado starters provide superior starting power over your stock starter. Starting 150ci. engines is not a problem when you have a Tornado.
- 7. Availability** — Our starters are always on our shelves, equating to less down time during an already short riding season.
- 8. 100% Tested** — All Tornado starters are tested several times during the manufacturing process at Tech Cycle's manufacturing facility before they are shipped. You will never receive a bad starter from our factory.
- 9. Full Warranty** — We stand behind our products, period.
- 10. Starting H-D style motorcycles is our specialty.** From our direct replacement, high torque Tornado starters to our Twister Open Primary Electric Start Kits and Cyclone Belt Drives, we have a system to start just about anything you can dream up.



Starter



Starter clutch



Ring Nose Cone Shaft



Builder kit



Solenoid repair kit





TRASK  
TURBO SYSTEMS



Trask Performance was founded in 2000, when Nick Trask followed his passion for motorcycles and performance, from New Zealand to the United States.

Nick knew that the only way to make his vision a reality was to risk it all and come to the United States to pursue his dream.

Fast forward to the present and Trask Performance has become the top leader in turbo systems for Harley-Davidson V-Rods, Big Twins, and Victory Motorcycles.

In addition to the turbo aspect of the business, Trask Performance is also one of the top tuning shops in the country.

Trask also manufactures many of its own products with the Trask name attached to them, and has been embraced by the media with dozens of motorcycle magazine articles, features, and covers. Magazines have featured Trask turbo systems, as well as a multitude of other Trask Products.

While the risk Nick took has certainly seemed to have paid off, both his vision and mission has remained steadfast.

Produce reliable monster horsepower, manufacture top quality products, provide optimum customer service, and always stay true to your vision of producing products and services that are "Nothing But The Best".







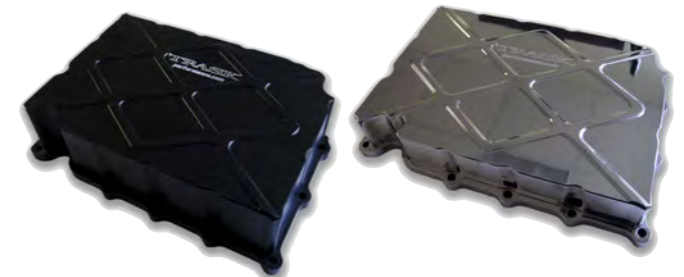



# TBR



*Two Brothers Racing headquarters is located in Santa Ana, California. With over 30 years in the motorcycle industry, Two Bros is a leading manufacturer of performance exhaust systems and aftermarket components. Inspired by a professional racing heritage, Two Bros makes exhaust systems for everything from sport likes to v-twin cruisers. Using the highest quality materials, all exhaust systems are TIG welded by hand and proudly made in the USA. With an eye for style as well as a passion for performance and sound, Two Brothers Racing invites you to feel what you have been missing.*





# Available Now for the 2018 Softail

Comp S and Megaphone Gen II styles available



Comp S Serie



Megaphone Gen II



Comp S Serie

Designed to deliver maximum Torque & Horsepower to the new Softail 2018 models, the new TBR 2-1 has an attitude unlike the others.

**Increased ground clearance for aggressive riding !**

The race inspired stainless steel headers shave pounds off the competition to ensure a long lasting, weather resistant, amazing sounding exhaust.

3 finishes to satisfy everybody ... Stainless Steel, Stainless Steel Black ... or Polished !

- TBR/4960199 ..... 2018 HD Softail 2-1 SS w/ Carb
- TBR/4960199B ..... 2018 HD Softail 2-1 Carbon BLK
- TBR/4960199P ..... 2018 HD Softail 2-1 Polished w/ Carb
- TBR/4970199 ..... 2018 HD Softail 2-1 GEN 2 Megaphone SS
- TBR/4970199B ..... 2018 HD Softail 2-1 GEN 2 Megaphone SS Black
- TBR/4970199P ..... 2018 HD Softail 2-1 GEN 2 Megaphone SS Polished

# Exhaust for Indian Scout

- Designed and tuned for increases max torque & horsepower
  - All tig weld done by hand
- Swept-up muffler for enhanced ground clearance
  - Mandel bent stainless steel tubing
  - Carbon fiber end cap
- High temp SS whool and packing material
  - Accept stock O2 sensor
  - Made in the USA



TBR/4610199 ... Indian Scout 2017 COMP 2-1 SS  
 TBR/4610199B ... Indian Scout 2017 COMP 2-1 Black

## INTRODUCING OUR NEW JUICEBOX

**TBR**  
**JUICEBOX GEN 4**  
 Premium Fuel Controller

1 2 3 4 5 6 7 8

- MODE +  
 TWPBROS.COM MADE IN THE USA

FOR RACE USE ONLY

- + Currently available for the 2006-2017 HD Dyna (103 Motor) and 2014-2017 HD Sportster XL1200
- + No dyno tuning needed; dyno'd map pre-installed on box
- + Uses load-based technology for the ultimate in tuning
- + User-friendly push button interface for ease of use
- + No laptop needed; simply plug it in and ride





# Available for the 2017+ Touring

Slip on and 2-1 systems

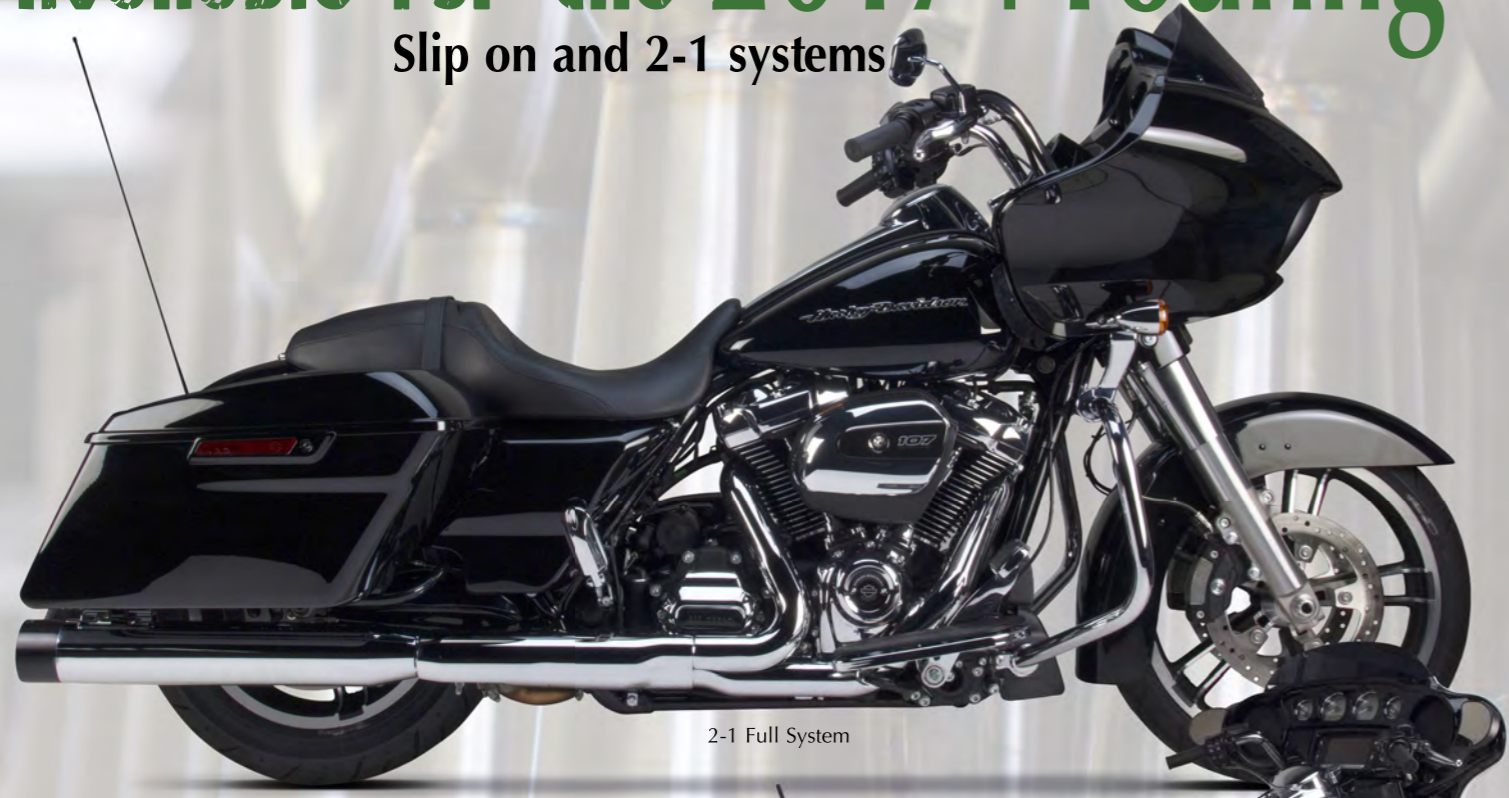

2-1 Full System



Dual Slip-On system

Designed to deliver maximum Torque & Horsepower to the new 2017 and up M-8 Touring  
**Fabricated and dyno tuned for maximum clearance and performance !**

Certified Chrome or Black finishes with your choice of end cap

3 end cap options: Carbon Fiber, Polished Aluminum or Black Aluminum

Handcrafted in the USA

- TBR/4550499D ... HD Touring '17 (Carbon End Cap) Chrome Slip-On System
- TBR/4550499DB ... HD Touring '17 (Carbon End Cap) Black Slip-On System
- TBR/4560499D ... HD Touring '17 (Blk Aluminum End Cap) Chrome Slip-On System
- TBR/4560499DB ... HD Touring '17 (Blk Aluminum End Cap) Black Slip-On System
- TBR/4560499DBP ... HD Touring '17 (Polished Aluminum End Cap) Black Slip-On System
- TBR/4680199 ... HD Touring '17 (Carbon End Cap) Chrome 2-1 System
- TBR/4680199B ... HD Touring '17 (Carbon End Cap) Black 2-1 System
- TBR/4640199 ... HD Touring '17 (Blk Aluminum End Cap) Chrome 2-1 System
- TBR/4640199B ... HD Touring '17 (Blk Aluminum End Cap) Black 2-1 System
- TBR/4640199BP ... HD Touring '17 (Polished Aluminum End Cap) Black 2-1 System



# Comp V The Revolutionary Air Cleaner Direct Velocity or High Flow Air Intake System

V-twin buffs that want a leg upon the competition will find their answer in the patent pending technology of the Comp-V High-Flow Intake System with V-Stack.

**This 2-in-1 system** gives riders the option to quickly change the threaded V-Stack for a direct air intake or threaded billet cap to bring in air through the high-flow air filter.

With significant performance gains over the stock H-D tear drop air cleaner cover and can't miss head turning TBR style, you'll be the envy of your riding buddies.



**< Option 1:**  
End-cap utilizes high-flow filter



**< Option 2:**  
Velocity stack straight air induction

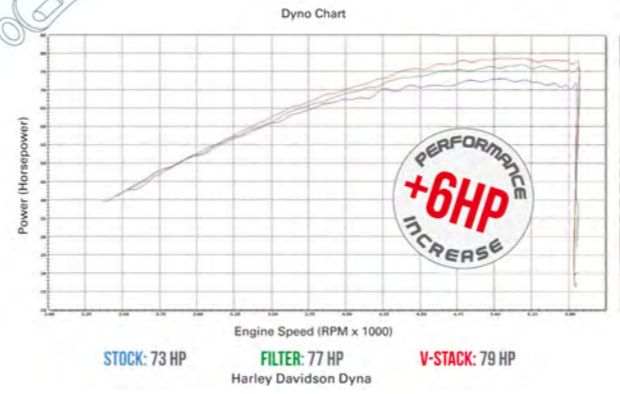

- TBR/377-01-V ... Sportster 07-17 Comp V-Stack Intake
- TBR/376-01-V ... Dyna - HD Twin Cam (08-17) Comp V-Stack Intake
- TBR/375-01-V ... Softail- HD Twin Cam (08-15) Comp V-Stack Intake
- TBR/387-01-V ... FL Throttle By Wire (08-16) Comp V-Stack Intake





Tedd Cycle was established in 1969 in Vails Gate, NY and was referred to back in the day as "Ted's Cycle Shed." In the beginning, they started by building laced wheels and selling used parts along with some army surplus parts. They also began to manufacture and sell hard to find chopper parts such as sissy bars, spring forks, custom oil tanks and a chrome plating service.

Due to the ever growing demand for replica and aftermarket parts, Tedd Cycle established V-Twin Mfg. in 1977. Some of the first specially designed parts included Forward Control Kits, Oil Tank Covers, Star Hubs and various Flathead parts.

Around the same time, the company began to establish a dealer network. Dealers would purchase the custom made parts for sale in their own shops, helping to spread the news about V-Twin Mfg. In 1978, V-Twin Mfg. printed its first 16 page parts catalog. In 1981, Tedd Cycle, Inc. was formed after several years of success and having now been established as one of the premiere companies for genuine and aftermarket parts for Harley-Davidson motorcycles. By 1991, the company outgrew the original "shed" and moved to Newburgh, New York, which is less than ten miles from their original location. The original Ted Cycle Shed is still used today to store samples and related development projects.

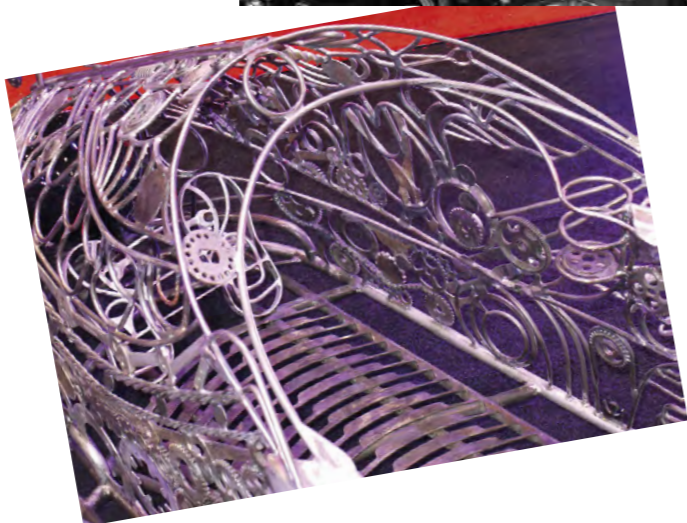



**When it comes to chopper stuff, hard to find parts and classic/vintage supplies no other name has the choice that Vtwin offers !**

Today, V-Twin Mfg. manufactures thousands of parts both within the United States and around the world and their catalog consists of over 1200 pages and contains over 30,000 parts from vintage to the present.

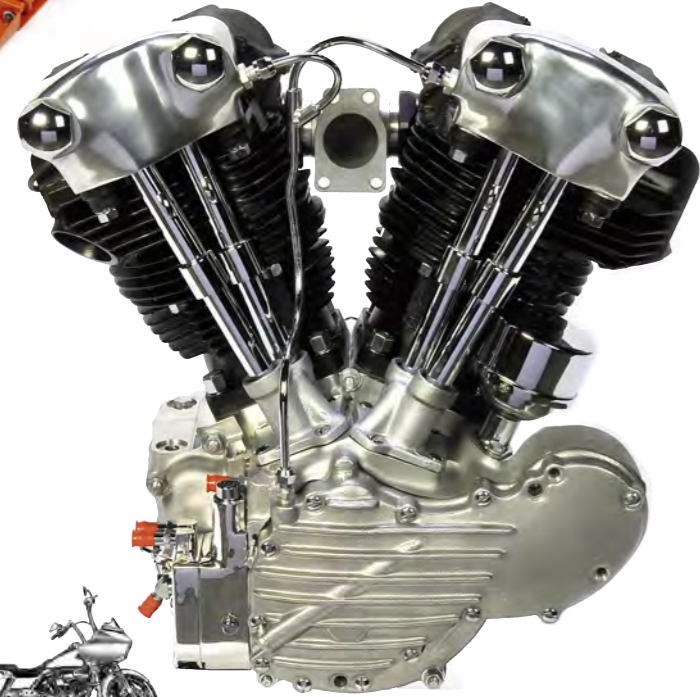

**Knucklehead 87" Long Block**  
Assembled and tested for oil pressure. 87" Knucklehead long block features alternator left hand case and generator right hand case. Long block is assembled with S&S crankcases, Sifton oil pump, S&S 4-5/8" flywheels, Timken main bearings, lighting cam with matched pinion gear, Torrington cam needle bearing and main pinion bearing. Cylinders are pre fitted with forged 8.25:1 pistons. Cylinder heads are fitted with valves, springs and collars. Heads feature stock intake and exhaust ports. Each 87" long block is assembled with a natural finish cam cover, lifter block, automatic advance distributor and solid lifters. Long block is pre-run and tested for proper oil pump pressure. Sprocket shaft is correct length for 1970-up 4 or 5 speed transmission assembly. Manufacturer's Statement of Origin is supplied.



**Replica Knucklehead 74" Long Block**  
Replica 74" Knucklehead long block is fully assembled and tested for oil pressure. The carburetor and generator is not included. Manufactured of imported and domestic components, assembled in the U.S.A. Unit features Replica crank cases, rocker boxes with natural finish and overhead oiler provision from timing cover. Also, features heads with parkerized lower valve cover cups and tops, cast iron Sifton flywheels assembled with stock rods and Torrington rollers with steel cages, valve train with tappet assembly with Sifton Lightning Cam, pushrods & chrome pushrod covers. Cam cover is smooth 1940 style. Replica cast iron cylinders are fitted with 8.5:1 cast pistons and Hasting rings, cases are made in Germany by Motortech for the original detail in the castings, replica cast iron oil pump with early style iron cover, distributor mechanical advance with corresponding relay mount with distributor post guide slot and 4 bolt intake manifold Linkert style are also included to accept 4 bolt M-74 brass linkert carburetor. Manufacturer's Statement of Origin is supplied.

**Replica Panhead 74" Long Block**

Replica alloy Panhead 74" long block with stock exhaust and oil pump. Panhead kit includes all the cast features just like the original model Panhead by Motortech of Germany. 74" Replica alloy Panhead long block with replica type heads and stock exhaust ports and cases. Assembly includes cast iron oil pump. OE number boss is provided on left side. Actual case numbers are on right side. Sprocket shaft supplied is for 4-speed stock transmission. Use 1948-1954 style plumber intake manifold. Kit includes zinc plated tappet blocks, stainless steel pan cover set, alloy d-rings, alloy cover with fittings, cast cam cover, chrome pushrod cover, OE type exhaust sport spigots, and cadmium finish screws. The brass seals are tightened by large hex nuts. Manufacturer's Statement of Origin is supplied.

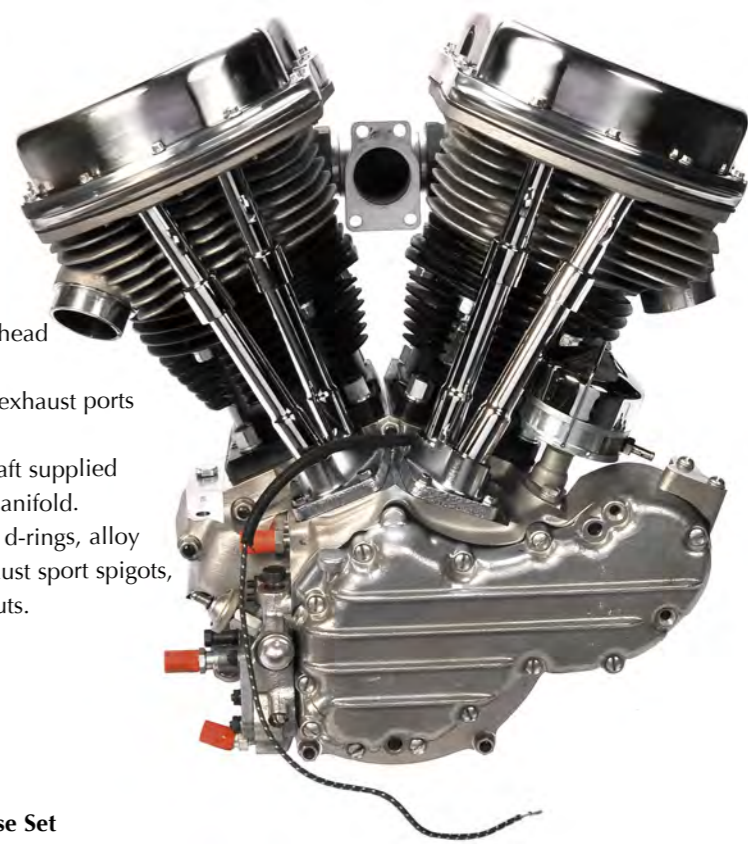

**Knucklehead Engine Case Set**  
74" motor case for knucklehead motors accurately cast and machined. Features a natural cast finish and a blank number boss. Case set is designed for replacement of the original cases. No serial numbers are provided with these case sets. Case sets do not include pinion and sprocket shaft races. Case is made in Germany by Motortech and features the original detail in the casing.



**Knucklehead Cam Chest Assembly Kit**  
V-Twin Knucklehead cam chest assembly kit includes internal Big Twin replacement type parts for years listed, including a Sifton cam, replica finned cam cover for 61 and 74 engines, and hardware.





**Flywheel Assembly with 4-5/8" Stroke**  
Assembly is for 1973-1984 Big Twin and are machined from heat treated steel forgings. Cover features natural cast finish, as original!



**Motor Sprocket Shaft**  
Sifton Brand motor sprocket shaft features precision ground outer diameter with accurately milled spline!



**Connecting Rod Assembly H-Beam**  
Features forged and machined H-Beam design of certified 4340 steel with multi-staged heat treatment.

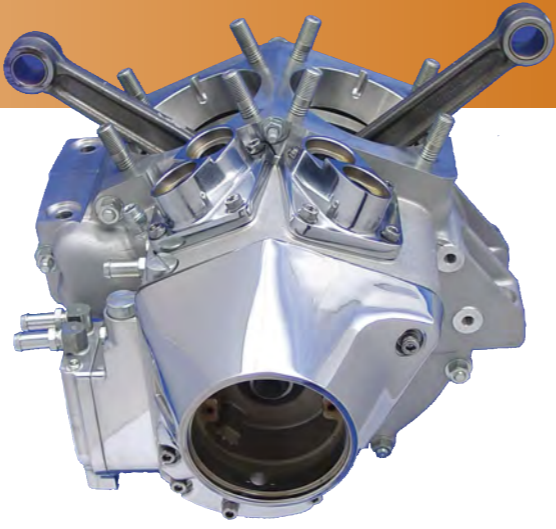

**Shovelhead 80" Short Block**  
V-Twin short block is shipped fully assembled and a Manufacturer Statement of Origin is supplied.



**Performance Cam Kit**  
Sifton performance cam kit includes cam, solid lifters, pushrods and chrome lifter bases. Cam lift is .412 for 1970- Early 1977 Shovelhead models.

### Replica 4-Speed Jockey Transmission

Replica 4-speed transmission is jockey type with kicker cover. Kick starter is a natural finish. Aluminum kick arm and kicker spring features a gloss black paint finish. It includes original cast case with early style main drive gear, 44 rollers and 2:1 ratio speedometer drive gear, internal parts, original style aluminum kicker cover and components, clutch rod, throwout bearing, ratchet top with natural finish with chrome dust cover, one piece black kicker arm, mount studs, hub nut, 23 tooth drive sprocket, seal and key. Transmission comes fully assembled, and has an FL style 3.00:1.00 first gear ratio. This transmission is kick starter only.  
\*NOTE: This handshift transmission shifts 1-back and 3-forward.



### Replica 4-Speed Transmission

Replica 4-speed transmission with a 3.00 ratio features cast case internal parts, chrome kicker cover and components, clutch rod, throwout bearing, natural finish ratchet top with chrome dust cover, arm, mount studs, hub nut, seal and key. Transmission is fully assembled for Big Twin models. Cases have mount lugs to accept aluminum inner primary covers. Speedometer drive gear is supplied and has a 1:1 ratio. Torrington needle bearings are used throughout. The shift pattern will be reversed when installed in mid-shift as it has the FL type ratchet top to be used with forward controls.

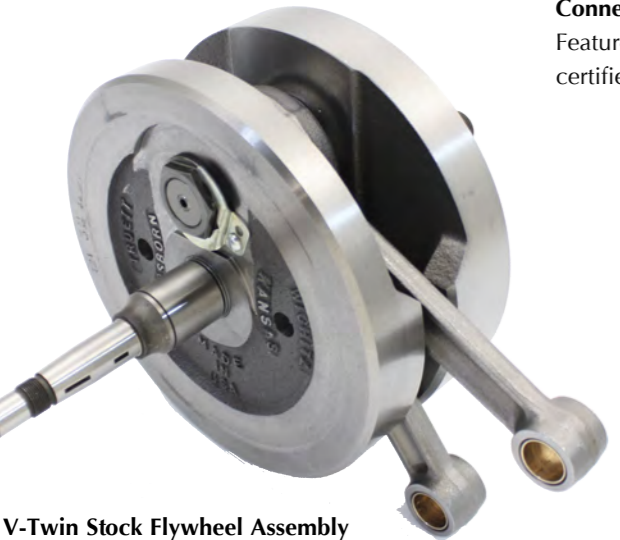

**V-Twin Stock Flywheel Assembly**  
Shipped assembled and trued with shafts. Unit features full weight stock flywheels. Assembly is for 74" motor.



**Kick Starter Cover Cast**  
Natural Cast finish Kick starter cover with zinc plated clutch shaft bushings is for 4 speeds. Two bushings and seal installed at kicker hole.



**Replica Oil Pump**  
Replica oil pump includes cast outer cover without rotator.



**Chrome Kick Starter Kit**  
Chrome heavy duty kit features a smooth thick wall kick starter cover and heavy duty forged "thick" beefy kick starter arm.



**Natural Alloy Knuckle Kick Starter Pedal**  
Billet knuckle style kick starter pedal has a natural alloy finish. The metal rod is constructed of steel.



**Bicycle Kick Starter Pedal and Axle Assembly**  
Bicycle kick starter pedal and axle assembly includes bushing, bolt, and spring clip.



**Kick Starter Gear and Shaft Kit**  
Sifton kick starter kit includes large gear, corresponding shaft, nut, lock tab, and thrust washer.

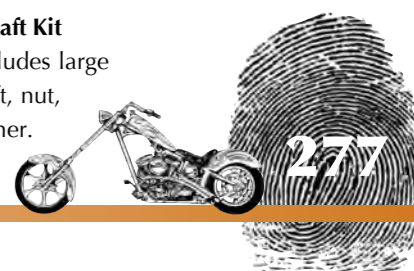



When it comes to frames for building Old School or restore your Harley Davidson, VGMotorcycle offers a wide range of Tw approved frames since 1990. The frames are available in Straightleg or Wishbone, the frames are built for 1200 Flathead, Knucklehead, Panhead, Shovelhead, Evo or TwinCam Engines with 4 or 5 speed transmissions the Trike frames are only available in Straightleg and there is also an Hardtail frame for Sportster Engines.





All frames are manufactured from seamless thick-wall tubing, nodular cast iron steeringhead, lugs and joints. All frames are MIG and TIG welded.

We can built the rear section for the latest tire sizes and at the front end rakes up 46° with 6" stretch or more and 28" overstock front fork, it is no problem all frames can be calculated in advance for the best trail with our special computer program, so all frames have an excellent road performance.

The Big Twin frames are homologated (TUV) to a maximum weight of 600kg and an engine of 180 horsepower and the Sportster frames can bear 500kg and 150 horsepower.

So we produce the STD frames and one-off custom made frames or special series for our customers because that's what we started with, but no matter what the next fashion is, VG MotorCycle is prepared for the future.

## VG/FR01

And you have to make the choice of year  
With individual request

## VG/FR09



For Flathead / Knucklehead.  
Model year 1936 with neck 28°  
With German TÜV certificate  
Individual requests are possible

For Flathead / Knucklehead.  
Model year 1937 with neck 28°  
With German TÜV certificate  
Individual requests are possible



For Flathead / Knucklehead.  
Model year 1938 – 1940 with neck 28°  
With German TÜV certificate  
Individual requests are possible

For Flathead / Knucklehead.  
Model year 1946 – 1947 with neck 30° "Bull Neck"  
With German TÜV certificate  
Individual requests are possible



## Harley Swingarm Frames

Our Harley swingarm frames are available in:

- Harley swingarm frame Duo Glide
- Harley swingarm frame FLH/FX
- Harley swingarm frame XL
- Harley swingarm frame Oldschool
- Harley swingarm frame Right Side Drive (RSD)



### Swingarm FLH/FX style

#### Specifications:

For pan / shovel / Evo / TCA + adaptor.  
In different rakes ranging from 30° to 46°.  
In different stretches ranging from 0" up to 5".  
For 4 or 5 speed gearboxes.  
In 10mm offset of motor and gearbox.  
Tankmounts for Fatbob, Flatside or Chopper.  
With German TÜV certificate.  
Individual requests are possible



### Swingarm Oldschool

#### Specifications:

For Panhead / Shovelhead / Evo / TCA + adaptor  
Duo slide style or FX/FLH.  
Wishbone or Straightleg fronttubes.  
In different rakes ranging from 30° to 46°.  
In different stretches ranging from 0" up to 5".  
For 4 or 5 speed gearboxes.  
In standard or 10mm offset of motor and gearbox.  
Tankmounts for Fatbob, Flatside or Chopper.  
With German TÜV certificate.  
Individual requests are possible



### Swingarm STD

#### Specifications:

For Panhead / Shovelhead / Evo / TCA + Adaptor plate  
Duo Glide style ('58-'64) or FX/FLH style.  
In different stretches ranging from 0" up to 5".  
For 4 or 5 speed gearboxes.  
In standard or 10mm offset of motor and gearbox.  
Tankmounts for Fatbob, Flatside or Chopper.  
With German TÜV certificate.  
Individual requests are possible



### Swingarm XL-wide

#### Specifications:

For pan / shovel / evo / TCA + adaptor.  
Duo Glide style or FX/FLH.  
In different rakes ranging from 30° to 46°.  
In different stretches ranging from 0" up to 5".  
For 4 or 5 speed gearboxes.  
In 10mm offset of motor and gearbox.  
Up to 280 reartires  
Tankmounts for Fatbob, Flatside or Chopper.  
With German TÜV certificate.  
Individual requests are possible



### Swingarm RSD

#### Specifications:

For pan / shovel / Evo motor / TCA + adaptor.  
Old Duo Glide style or FX/FLH.  
In different rakes ranging from 30° to 46°.  
In different stretches ranging from 0" up to 5".  
For 4 or 5 speed gearboxes.  
Tankmounts for Fatbob, Flatside or Chopper.  
With German TÜV certificate.  
Individual requests are possible

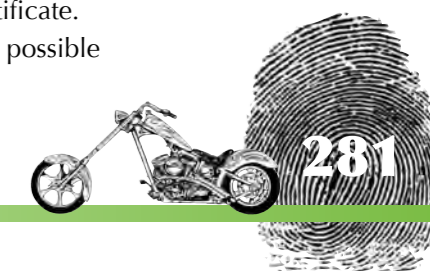

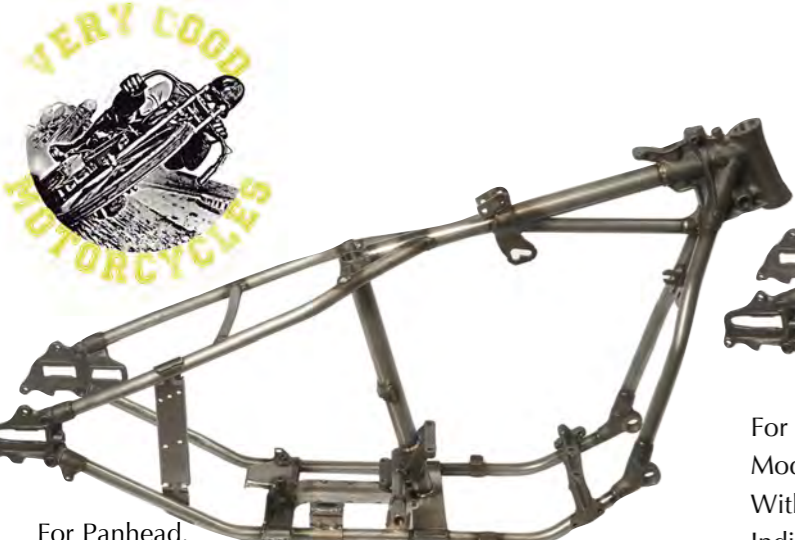

For Panhead.  
Model year 1948 with neck 30° "Wishbone"  
With German TÜV certificate  
Individual requests are possible



For Panhead.  
Model year 1954 with neck 30° "Wishbone"  
With German TÜV certificate  
Individual requests are possible



For Panhead.  
Model year 1949 – 1951 with neck 30° "Wishbone"  
With German TÜV certificate  
Individual requests are possible



For Panhead.  
Model year 1956 – 1957 with neck 30° "Straightleg"  
With German TÜV certificate  
Individual requests are possible

### Harley Swingarms

VG Motorcycle offer a wide range of Swingarms in many sorts and designs. Every swingarm is CAD designed and TÜV approved.

The VG motorcycle swingarms will accept rear tires from stock uptail the huge 360 wide tires. Of course VG Motorcycle can also make the matching frame for those swingarms.

#### FX Swingarm – STD

Suitable for standard frames, 10mm offset frames and for extra wide frames.

Chain tensioners included.  
The following parts are to be ordered separately axle and bearings for the assimilation in the frame and rearaxle.  
With German TÜV certificate.  
Individual requests are possible

#### FX Swingarm – dragstyle

Suitable for standard frames, 10mm offset frames and for extra wide frames.

Chain tensioners included.  
The following parts are to be ordered separately: axle and bearings for the assimilation in the frame rearaxle.  
With German TÜV certificate.  
Individual requests are possible

### Harley Softail Frames

Our Harley softail frames are available in Harley standard (STD), Harley extreme (XL wide), Harley Old School, Harley Ride Side Softail STDDrive (RSD) or Harley Single Tube frames.

#### Softail STD

For Panhead / Shovelhead / Evo / TCA + Adaptor  
In different rakes ranging from 30° to 46°  
In different stretches ranging from 0" up to 5" in height  
For 4 or 5 speed gearboxes  
In standard or 10mm offset of motor and gearbox  
Tankmounts for Fatbob, Flatside or Chopper  
With German TÜV certificate  
Individual requests are possible

#### Softail Oldschool

For Panhead / Shovelhead / Evo / TCA + adaptor  
Available with old style swingarm  
Softail frame in old style look  
Wishbone or Straightleg fronttubes  
In different rakes ranging from 30° to 46°  
In different stretches ranging from 0" up to 5"  
For 4 or 5 speed gearboxes  
In standard or 10mm offset of motor and gearbox  
Tankmounts for Fatbob, Flatside or Chopper  
With German TÜV certificate  
Individual requests are possible

#### Softail Single tube

For Panhead / Shovelhead / Evo / TCA + adaptor  
In different rakes ranging from 30° to 46°  
In different stretches ranging from 0" up to 5" in height  
For 4 or 5 speed gearboxes  
In standard or 10mm offset of motor and gearbox  
Tankmounts for Fatbob, Flatside or Chopper  
With German TÜV certificate  
Individual requests are possible

### Harley Swingarms

VG Motorcycle offer a wide range of Swingarms in many sorts and designs. Every swingarm is CAD designed and TÜV approved.

The VG motorcycle swingarms will accept rear tires from stock uptail the huge 360 wide tires. Of course VG Motorcycle can also make the matching frame for those swingarms.

#### Swingarm – Softail – STD

Available for Softail EVO, Softail TwinCam with 3/4" or 25 mm.  
With German TÜV certificate.  
Individual requests are possible

#### Swingarm – Softail – Offset

Available for Softail EVO, Softail TwinCam, with 3/4" or 25 mm.  
Also available for RSD.  
For 200 until 360 tires!  
With German TÜV certificate.  
Individual requests are possible

#### Softail XL-wide

For Panhead / Shovelhead / Evo / TCA + adaptor  
In different rakes ranging from 30° to 46°  
In different stretches ranging from 0" up to 5" in height  
In different stretches: 0" / 2" or 5" in length  
For 4 or 5 speed gearboxes  
In standard or 10mm offset of motor and gearbox  
Up to 300 tires  
Tankmounts for Fatbob, Flatside or Chopper  
With German TÜV certificate  
Individual requests are possible

#### Softail RSD

For Panhead / Shovelhead / Evo. / TCA + adaptor  
In different rakes ranging from 30° to 46°  
In different stretches ranging from 0" up to " in height  
For 5/6 speed RSD gearboxes  
In standard or 10mm offset of motor and gearbox  
Tankmounts for Fatbob, Flatside or Chopper  
With German TÜV certificate  
Individual requests are possible

#### Softail Twin Cam TCB

For TwinCam 88b unit  
In different rakes ranging from 30° to 46°  
In different stretches ranging from 0" to 5" in height  
Up to 300 tires  
Tankmounts flatside or chopper  
With German TÜV certificate  
Individual requests are possible

#### Swingarm – Softail – Oldschool

Suitable for the Old Style Softail Frame.  
Also available in offset for wide tires.  
Swingarm fabricated for disc or hydraulic drum brakes.  
Axle an chain-tensioners to be ordered separately.  
With German TÜV certificate.  
Individual requests are possible

#### Softail – Dragstyle

Suitable for std frames, 10mm offset frames and for extra wide frames.  
Chain tensioners included.  
For 200 until 360 tires.  
With German TÜV certificate.  
Individual requests are possible

#### Softail – Curved

Suitable for standard frames, 10mm offset frames and for extra wide frames.  
For 200 until 360 tires.  
With German TÜV certificate.  
Individual requests are possible



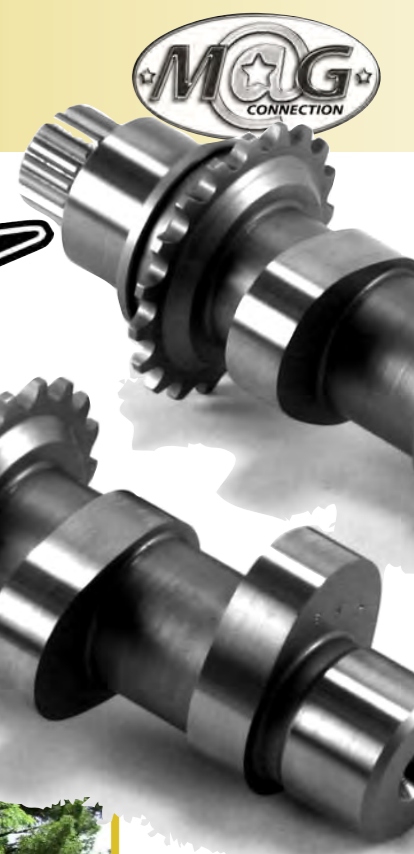

*Started in 1981, Zipper's has been known almost since its inception First locally, then nationally, now internationally as one of the nation's premier high performance machine shops and R&D facility dedicated to the Harley V-Twin. What we learn goes into everything we do, and we are still learning every day! All of our services are performed in-house to ensure quality products and maximum performance for your hard-earned dollar.*





# ZIPPERS PERFORMANCE



**ThunderMax** is an industry award winning, performance ECM designed specifically for EFI equipped Harley Davidson® motorcycles. This highly advanced, stand-alone tuning system utilizes proprietary AutoTune technology with wide-band oxygen sensors to deliver unmatched performance and rideability. ThunderMax comes 100% assembled, ready to install with no wire-cutting or splicing required. Simply replace the factory ECM and oxygen sensors, load a map, and enjoy your new ride!



**ThunderMax Benefits Include:**

- Easy to Install & Simple to Use
- Increased Engine Performance & Motorcycle Rideability
- Cooler, Smoother Running Engine
- Adjustable Idle Speed & Rev Limit Control
- No Dyno Required - Automatically Tunes for Riding Style & Riding Conditions
- Never Outgrow It - Easily Accommodates Bike Changes (Pipes, Cams, and More)
- 100% Engineered & Made in the USA
- 3-Year Factory Limited Warranty

**ThunderMax System Includes:**

- ThunderMax Performance Engine Control Module (ECM)
- Two (2) Wide-Band Bosch 5-Wire Oxygen Sensors (18mm) with AutoTune Connection Harness\*
- USB Communication Cable
- TMax Tuner Software Disc
- ThunderMax Quick Start Easy Install and Printable Comprehensive User's Manual

**ThunderMax Parts Application :**

- SOFTTAILS**  
**ZP/309-589** .... 2018 Softails  
**ZP/309-563** .... 2016-17 Softails  
**ZP/309-563** .... 2014-15 CVO Softails  
**ZP/309-363** .... 2011-13 CVO Softails  
**ZP/309-382** .... 2012-15 Softails  
**ZP/309-361** .... 2011 Softails  
**ZP/309-460** .... 2001-10 Softails

**ThunderMax Parts Application :**

- TOURING**  
**ZP/309-588** .... 2017-18 Touring  
**ZP/309-562** .... 2014-16 Touring  
**ZP/309-362** .... 2008-13 Touring  
**ZP/309-460** .... 2002-07 Touring  
**ZP/309-313** .... 99-01 Magneti Marelli  
**ZP/309-312** .... 95-98 Magneti Marelli

**ThunderMax Parts Application :**

- Dyna**  
**ZP/309-563** .... 2016-17 Dyna Lowrider  
**ZP/309-382** .... 2012-17 Dyna  
**ZP/309-485** .... 2004-11 Dyna

**ThunderMax Parts Application :**

- Sportster**  
**ZP/309-382** .... 2014-18 Sportster  
**ZP/309-485** .... 2010-13 Sportster  
**ZP/309-460** .... 2007-09 Sportster



**ThunderMax straight 18mm**  
**ZP/272-200** .... ThunderMax straight 18mm weld-in exhaust oxygen sensor bung with cap. For exhaust systems without installed 18mm oxygen sensor bungs. Drill exhaust pipe and weld in place. Sold individually, two required for installation.



**ThunderMax angled 18mm**  
**ZP/272-202** .... ThunderMax angled 18mm weld-in exhaust oxygen sensor bung with cap. For exhaust systems without installed 18mm oxygen sensor bungs. Drill exhaust pipe and weld in place. Sold individually, two required for installation.



In 1972 David Rash had a problem. He could not find the Exhaust Pipe he needed for his racing bike. He knew that the proper exhaust for his engine configuration would give him an edge over his competition. However, no such pipe was available. So he did the only thing he could do.

**He fabricated his own pipe.**  
 Forty years and 250,000 pipes later, D&D Exhaust exhaust systems are some of the leading performance motorcycle exhaust systems in the world. Built by reputation of excellent customer service, quality in every detail of the product, and the basic value of a system that performs as specified.

**Most of our system are available for the bike model and year needed ... most finishes including carbon for the mufflers Just ask for what you need !**



**Bobcat 2 in 1 System**  
 All Bobcat full systems are equipped with heat shields, bolt kit ,exhaust gaskets and baffles. All mufflers have a small D&D tag on the muffler. Each exhaust system is designed and dyno tested in our facilities. Our testing is done with the Harley SE Race Tuner. Every pipe is designed to increase low-end torque and horsepower. Performance increases are about 8 to 10 percent with the proper tune on the bike.



**Bobcat 2 in 1 System**  
 2:1 Fat Cat is a stepped header system at the head is 1 3/4" to 1 7/8" at collector and 2 1/4" where the muffler goes to the header.



**Fatcat 2 in 1 System**  
 All Bobcat full systems are equipped with heat shields, bolt kit ,exhaust gaskets and baffles. All mufflers have a small D&D tag on the muffler. Each exhaust system is designed and dyno tested in our facilities. Our testing is done with the Harley SE Race Tuner. Every pipe is designed to increase low-end torque and horsepower. Performance increases are about 8 to 10 percent with the proper tune on the bike.



**Fatcat 2 in 1 System**  
 2:1 Fat Cat is a stepped header system at the head is 1 5/8" to 1 3/4" to 1 7/8" at collector and 2 1/2" where the muffler goes to the header.



**Check on the web site for your model and ask for a quotation !**  
[www.danddexhaust.com/catalog/harley-davidson](http://www.danddexhaust.com/catalog/harley-davidson)



**Zipper's MaxFlow Air Filter Kits** Is your bike already equipped with a factory Stage 1 performance air cleaner? Raise the level another step! Our MaxFlow Stage 1 upgrade kit includes a specially designed, 100% washable pleated fabric filter made from multiple layers of surgical-quality cotton gauze material that traps the smallest dirt particles while providing dramatic flow increases. The element is 5/8" deeper than the factory performance filter it is designed to replace yielding over 60% more surface area than the Stage 1 filter. The kit includes required longer mounting hardware. 5-1/2" end diameter at cover mating surface. Takes about 5 minutes to install - the difference is immediately noticeable!



**Axtell Oil Bypass Valve** This is a new product designed and developed by the Axtell Mountain Motor team. This bypass valve consists of a precision-machined "needle and seat" that inserts in place of the factory oil pressure relief valve located within the Twin Cam® cam plate. With the factory OEM oiling system configuration, when oil pressure becomes excessive, it is bypassed from the high pressure side of the feed gerotor back to the low pressure side, "looping" the oil in the feed gerotor gears. This causes the introduction of air into the pressurized oil (aeration) - aerated oil is foamy and spongy, and results in lower oil pressure and volume. When this occurs, the entire oiling system is affected - engine heat and noise builds, piston oilers shut down sooner than designed, valve train and top end life is shortened. This system blocks the factory port back to the feed side of the pump and directs the bypassed oil into the cam chest. The scavenge side of the oil pump returns the excess oil to the oil tank and eliminates the oil "looping" and its negative effects.  
**ZP/620-103** .... Axtell Bypass Valve for All Harley-Davidson® and Screamin Cam Plates  
**ZP/413-902** .... Red Shift® Cam Chain Tensioners w/Axtell Oil Bypass

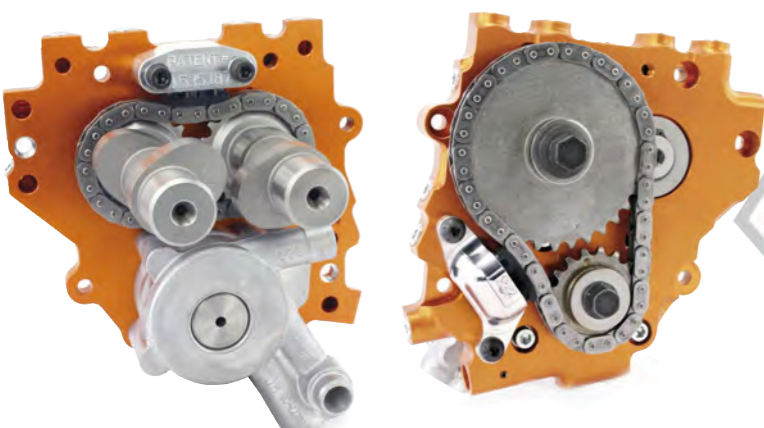

**Red Shift® Performance Cams for 2007-Up\* Twin Cam® Engines**  
 The 4.375 stroke in current H-D® engines has changed the cam dynamic from earlier model 88" engines. These Red Shift® grinds are developed as part of a system with the engine to produce the best results for your particular riding style. We recommend pressure testing cam plates for leaks, valving improvements, new cam bearings and performance tappets when upgrading cams in a Twin Cam® engine.



For more advice for your application contact: [info@mag-online.com](mailto:info@mag-online.com)



## Zipper's Muscle 107" Engine Kit for 2008-Up Touring Models



### Zipper's Muscle 107" Kit

New from Zipper's is the Muscle 107 kit for 2007-Up Twin Cam® engines. Zipper's has carefully developed this package with optimized compression, porting, camshaft design and inlet flow, combined with our best-in-class finish work, extensive dyno and ride testing to deliver a very balanced engine kit that will not disappoint! The Muscle 107 delivers fantastic power curves with both torque and horsepower reaching north of 120. This power is very smooth and broad, with torque over 100 ft/lbs from below 3,000 RPM's to above 6,000! Kit includes CNC porting with premium components on your heads, fitting forged, 3.937" bore domed pistons to your cylinders, Red Shift® cams and dual piston cam chain tensioners, Axtell oil bypass valve, Pro-Taper pushrods, quality gaskets, high flow injectors and MaxFlow air cleaner assembly with a pre-programmed ThunderMax® EFI controller. Requires separate purchase of H-D Screamin' Eagle throttle body (27713-08 58mm/TBW, 27623-05A 50mm/cable); not included. Everything else you need is supplied in a single part number!

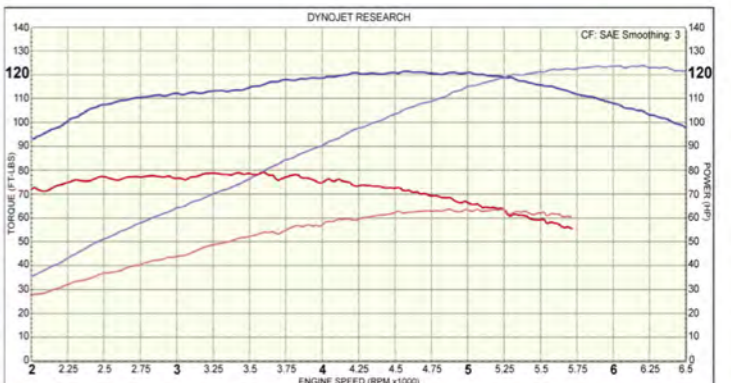

BLUE - 2009 FLHX Muscle 107" Kit with Red Shift 577 and D&D FatCat vs RED - 2011 FLHR Stock 96"

PART NO.	DESCRIPTION
ZP/ 517-347B	Muscle 107 Kit, '08-'15 Touring Models, Black
ZP/ 517-347S	Muscle 107 Kit, '08-'15 Touring Models, Silver
ZP/ 517-317B	Muscle 107 Kit, '07-'15 TC w/Cable Throttle, Black
ZP/ 517-317S	Muscle 107 Kit, '07-'15 TC w/Cable Throttle, Silver

Requires your heads and cylinders for modification. We keep exchange heads and cylinders in stock already modified for super turn-around; parts must be in nearly perfect cosmetic condition, expect the same from us. If preferred, Zipper's can process yours directly; expect 1-2 weeks completion time. You can also purchase any combination of kit components separately if desired.

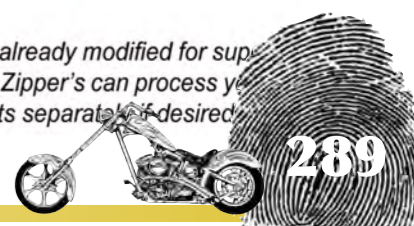



# Mag Connection ... the passion of your builds!



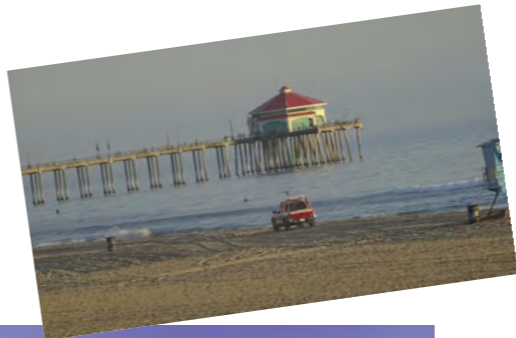
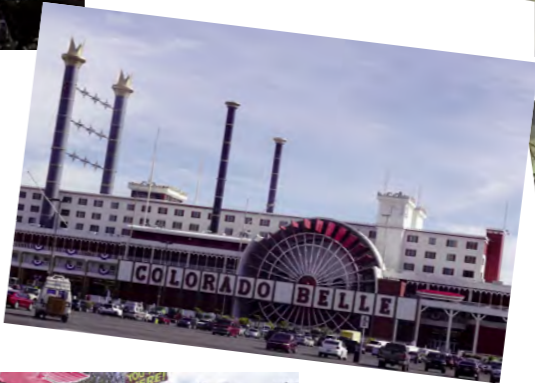



*All your needs for your builds!*